

Benennung: LOEWE.	
Basic-Board	
Q2500	
Code-Teile-Nr.: 604/390-88175	Index: D
Variante: alle Varianten 050-099	
erst.: Kestel	gpr.: Datum:
Datum: 08.01.2002	Datum:

88175D_34_050-099

08.01.02 Ex
10.1.02 Ri

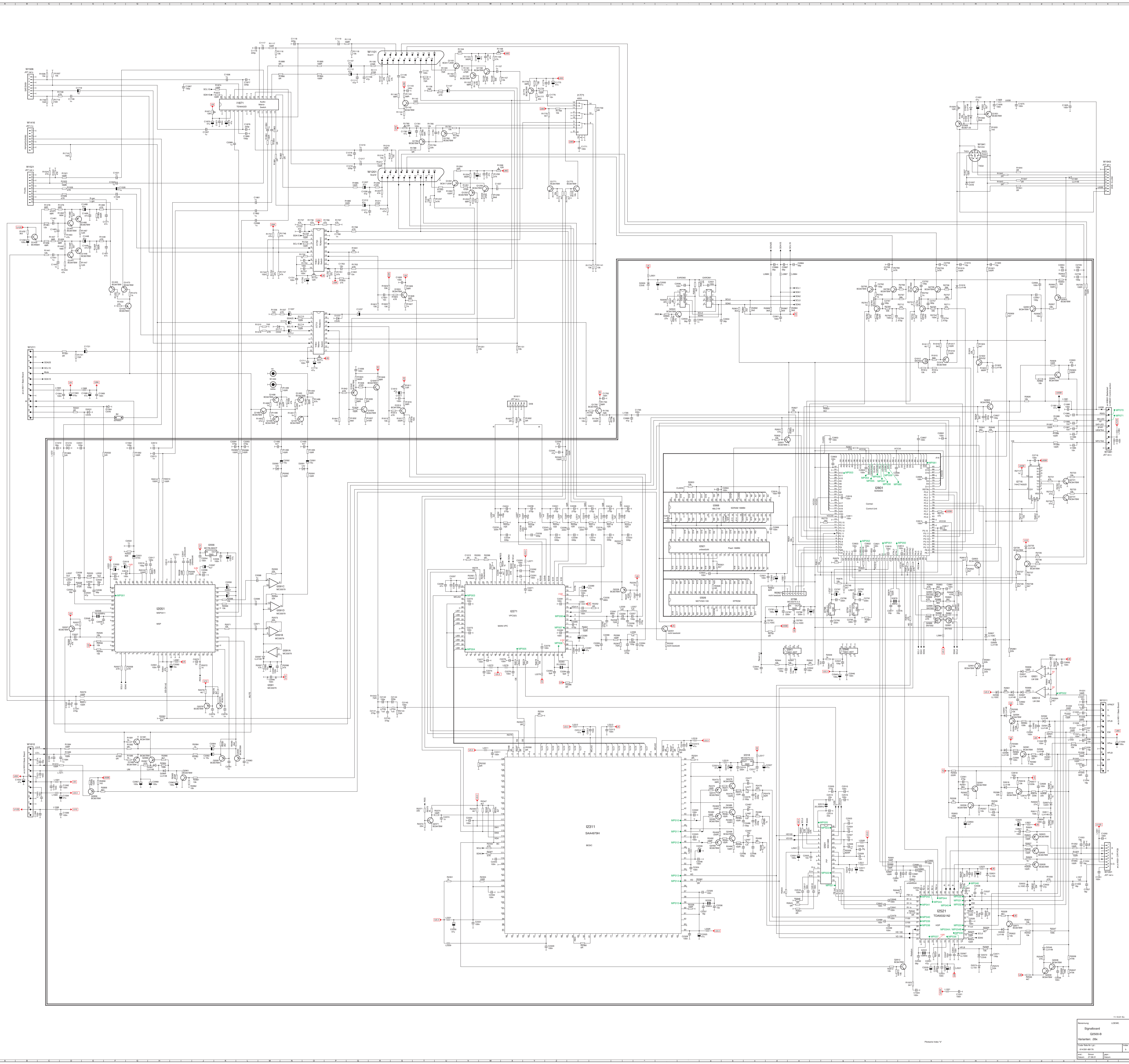

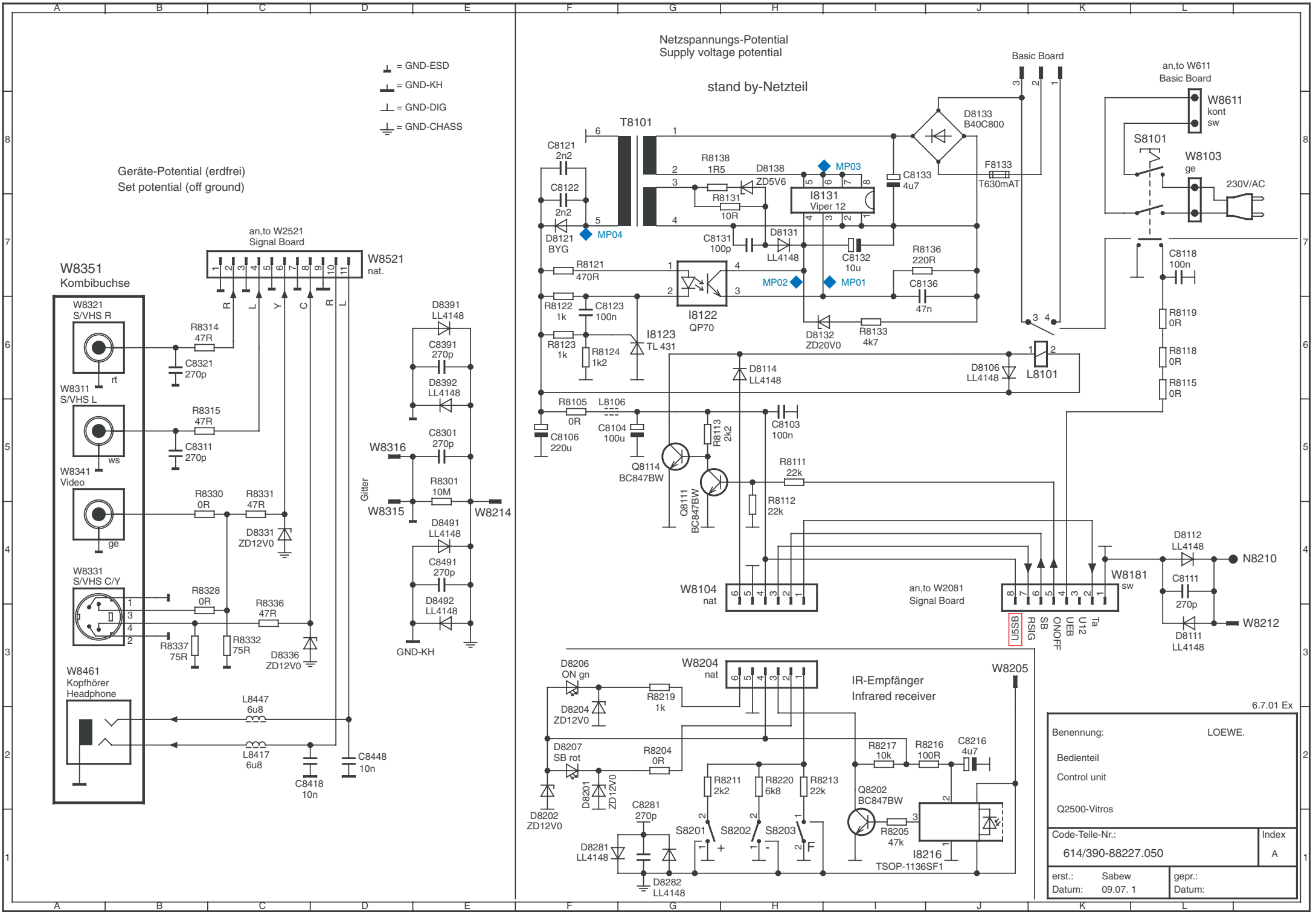

- ⊥ = GND-ESD
- ⊥ = GND-KH
- ⊥ = GND-DIG
- ⊥ = GND-CHASS

Geräte-Potential (erdfrei)
Set potential (off ground)

Netzspannungs-Potential
Supply voltage potential

stand by-Netzteil

Basic Board

an,to W611
Basic Board

Glitter

an,to W2081
Signal Board

Benennung:		LOEWE.	
Bedienteil		Control unit	
Code-Teile-Nr.:		614/390-88227.050	
erst.:	Sabew	gepr.:	
Datum:	09.07. 1	Datum:	
		Index	
		A	

6.7.01 Ex

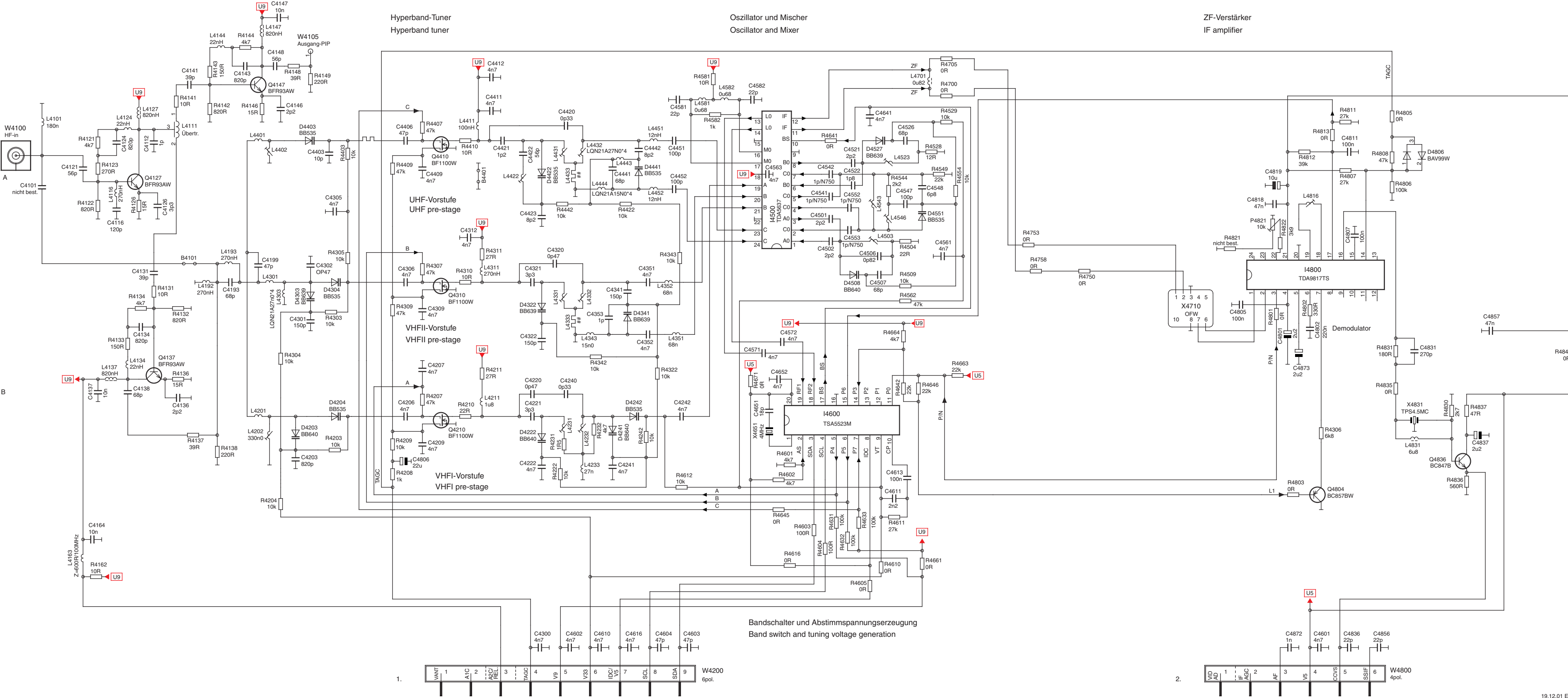

= Bauteil gedruckt
Component of printed circuit board

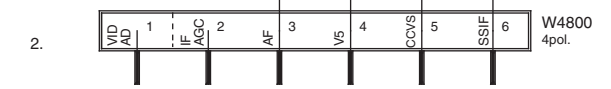
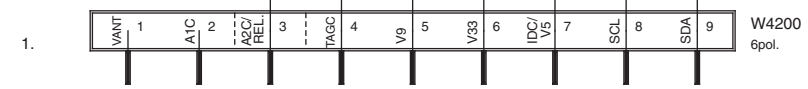

Benennung:	LOEWE.
TZF 97	
Variante:	Var.057
Code-Teile-Nr. Lpl.:	Index
390-087222	N
erst.: Thomale	gepr.: Müller
Datum: 19.12.1	Datum:

= Bauteil gedruckt
Component of printed circuit board

Hyperband-Tuner
Hyperband tuner

Oszillator und Mischer
Oscillator and Mixer

ZF-Verstärker
IF Amplifier

Bandschalter und Abstimmspannungserzeugung
Band switch and tuning voltage generation

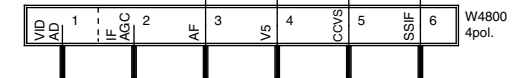
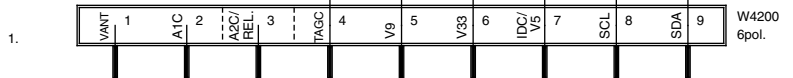

Benennung: LOEWE.	
TZF 97	
Variante: 058 (260-87271.051)	
Code-Teile-Nr. Lpl.:	Index
390-087222	N
erst.: Thomale	gepr.: Müller
Datum: 11.01.2	Datum:

11.01.02 Ex / 11.1.02 Ri

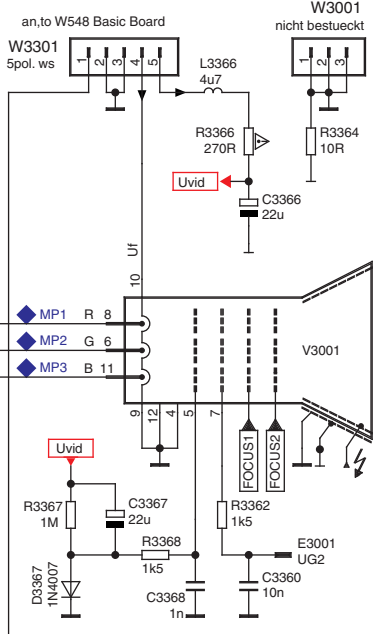
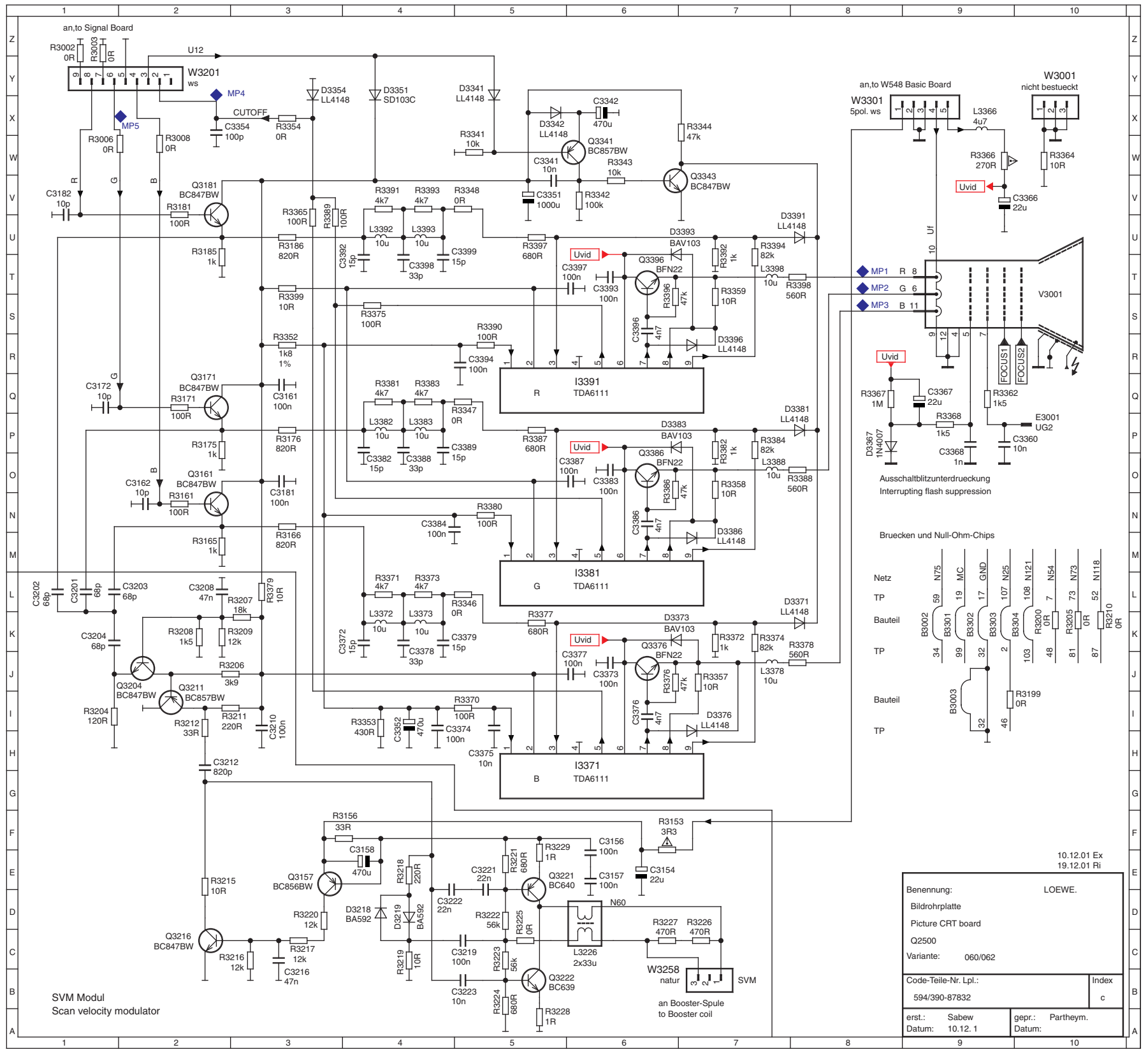

Bruecken und Null-Ohm-Chips

Netz	B3002	59	N75	
TP	B3301	19	MC	
Bauteil	B3302	17	GND	
TP	B3303	107	N25	
Bauteil	B3304	108	N21	
TP	B3200	OR	N54	
Bauteil	B3003	32	N73	
TP	B3304	103	N21	
Bauteil	R3199	OR	N118	
TP	B3003	32	N73	
Bauteil	R3199	OR	N118	
TP	B3003	32	N73	

Benennung:		LOEWE.	
Bildrohplatte			
Picture CRT board			
Q2500			
Variante: 060/062			
Code-Teile-Nr. Lpl.:		Index	
594/390-87832		c	
erst.:	Sabew	gepr.:	Partheym.
Datum:	10.12.1	Datum:	

10.12.01 Ex
19.12.01 Ri

SVM Modul
Scan velocity modulator

an Booster-Spule
to Booster coil

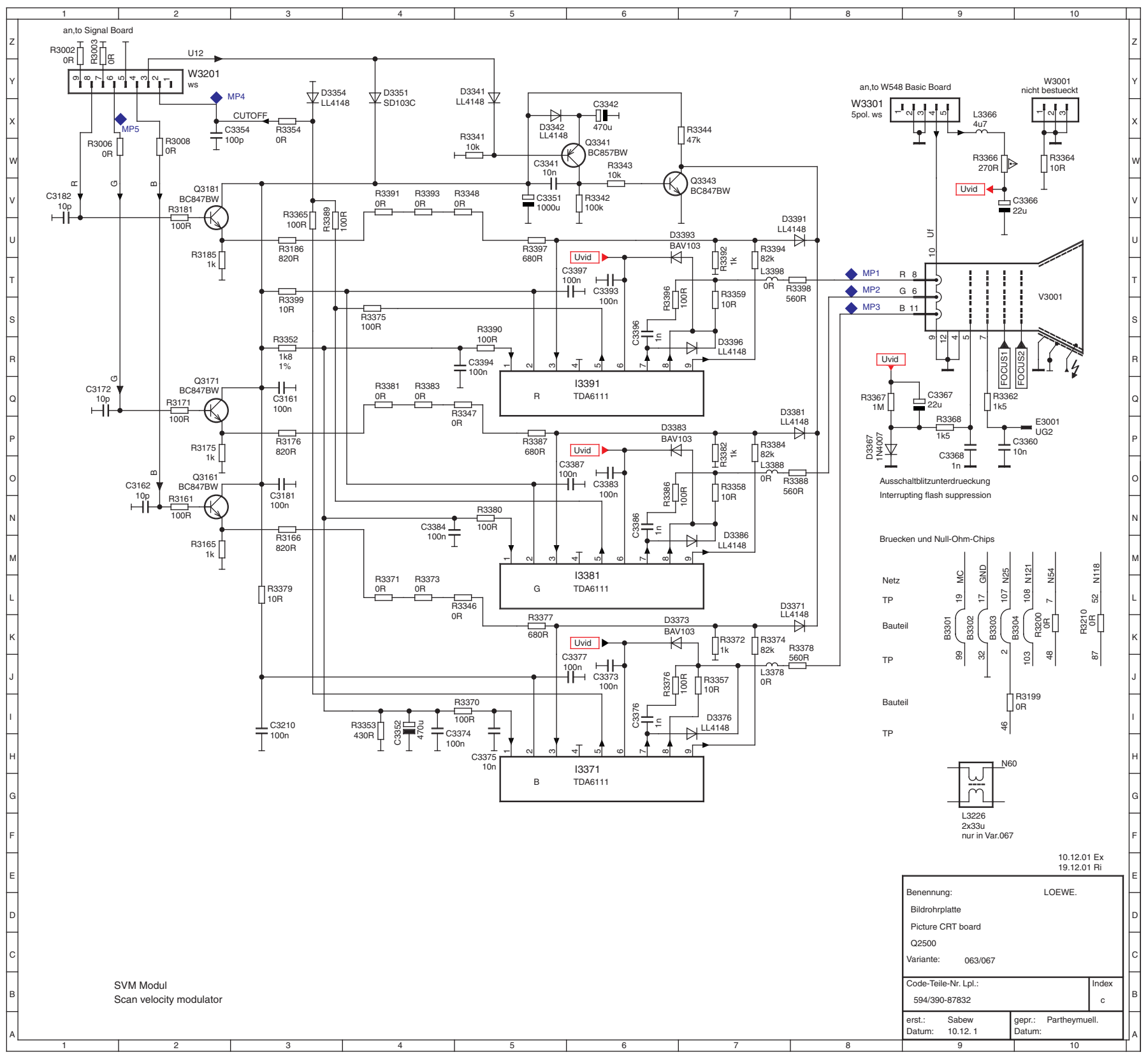

SVM Modul
Scan velocity modulator

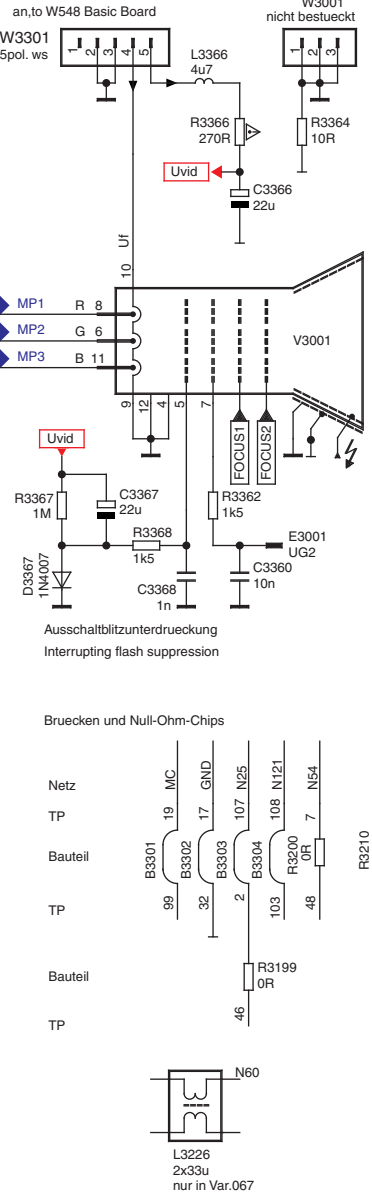

Benennung: LOEWE.	
Bildrohrplatte	
Picture CRT board	
Q2500	
Variante: 063/067	
Code-Teile-Nr. Lpl.:	Index
594/390-87832	c
erst.: Sabew	gepr.: Partheymuell.
Datum: 10.12.1	Datum:

10.12.01 Ex
19.12.01 Ri

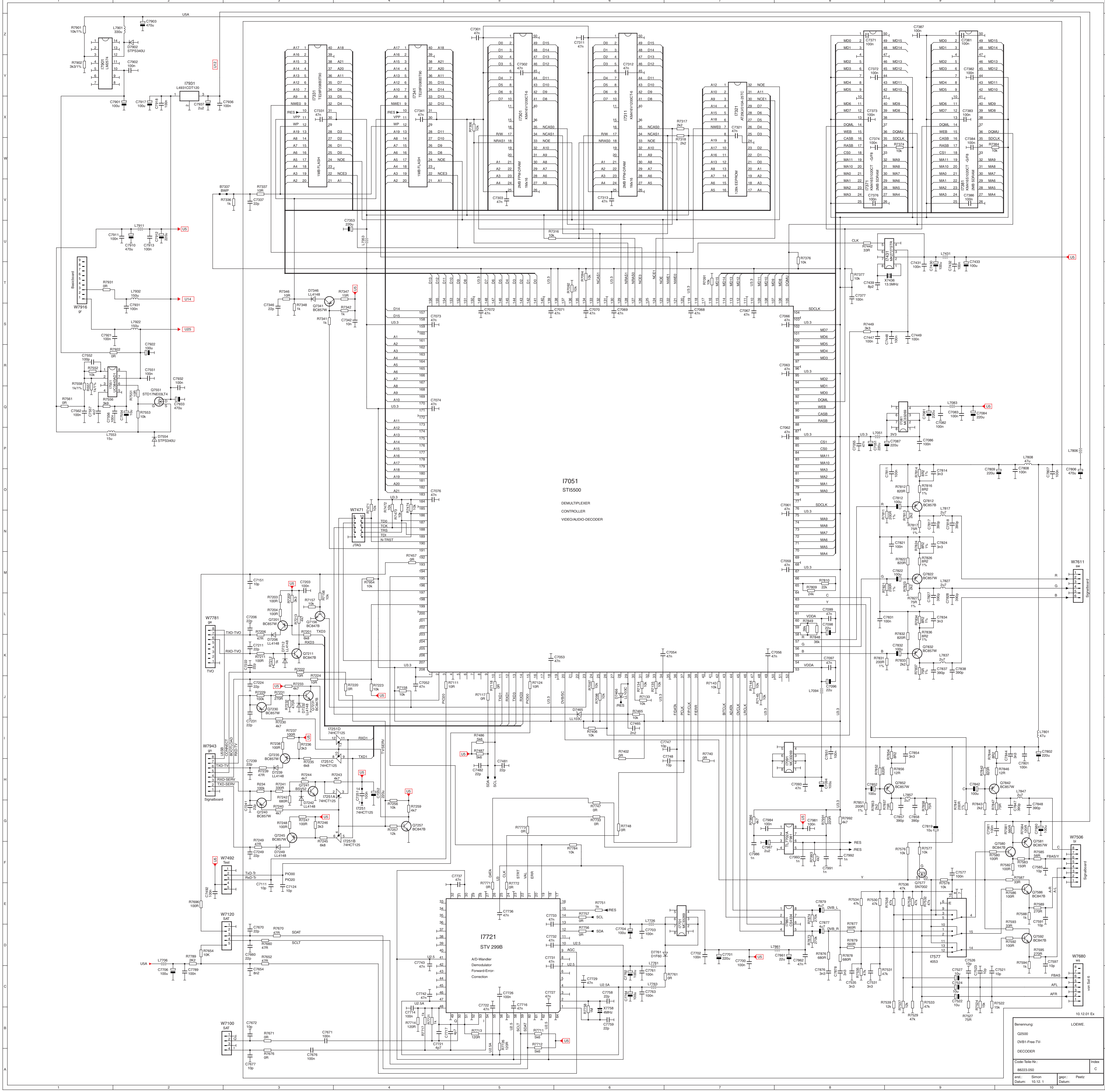

I7051
STI5500
MULTIPLIER
CONTROLLER
VIDEO/AUDIO-DECODER

I7721
STV 299B
AD-Wandler
Demodulator
Forward-Error-
Correction

Benennung: LOEWE
Q2500
DVB1-Free-TV-
DECODER
Code-Teile-Nr.:
88223.050
erst.: Simon gsp.: Peitz
Datum: 10.12.11 Datum:

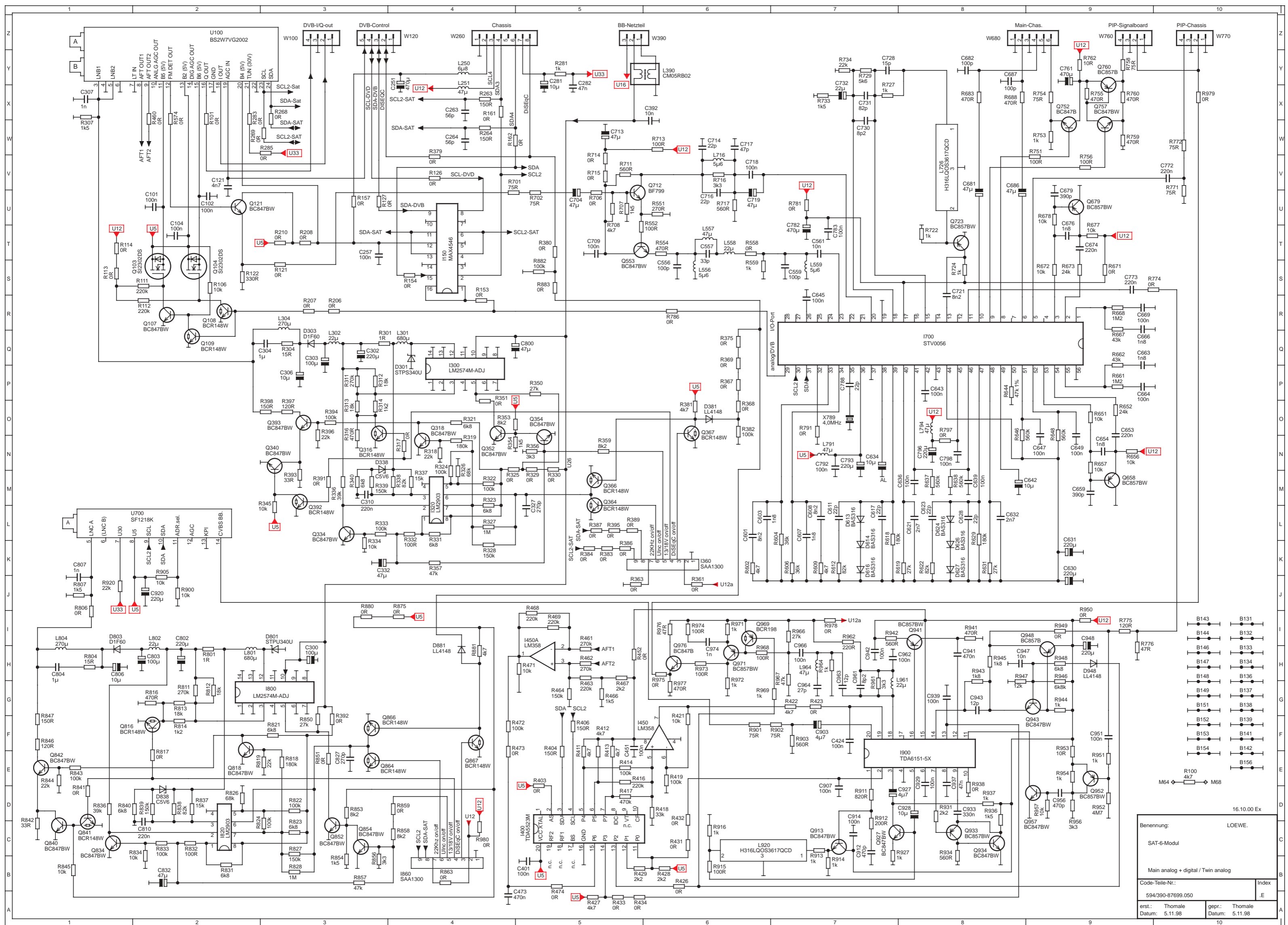

16.10.00 Ex

Benennung:	LOEWE.
SAT-6-Modul	
Main analog + digital / Twin analog	
Code-Teile-Nr.:	Index
594/390-87699.050	E
erst.: Thomale	gepr.: Thomale
Datum: 5.11.98	Datum: 5.11.98

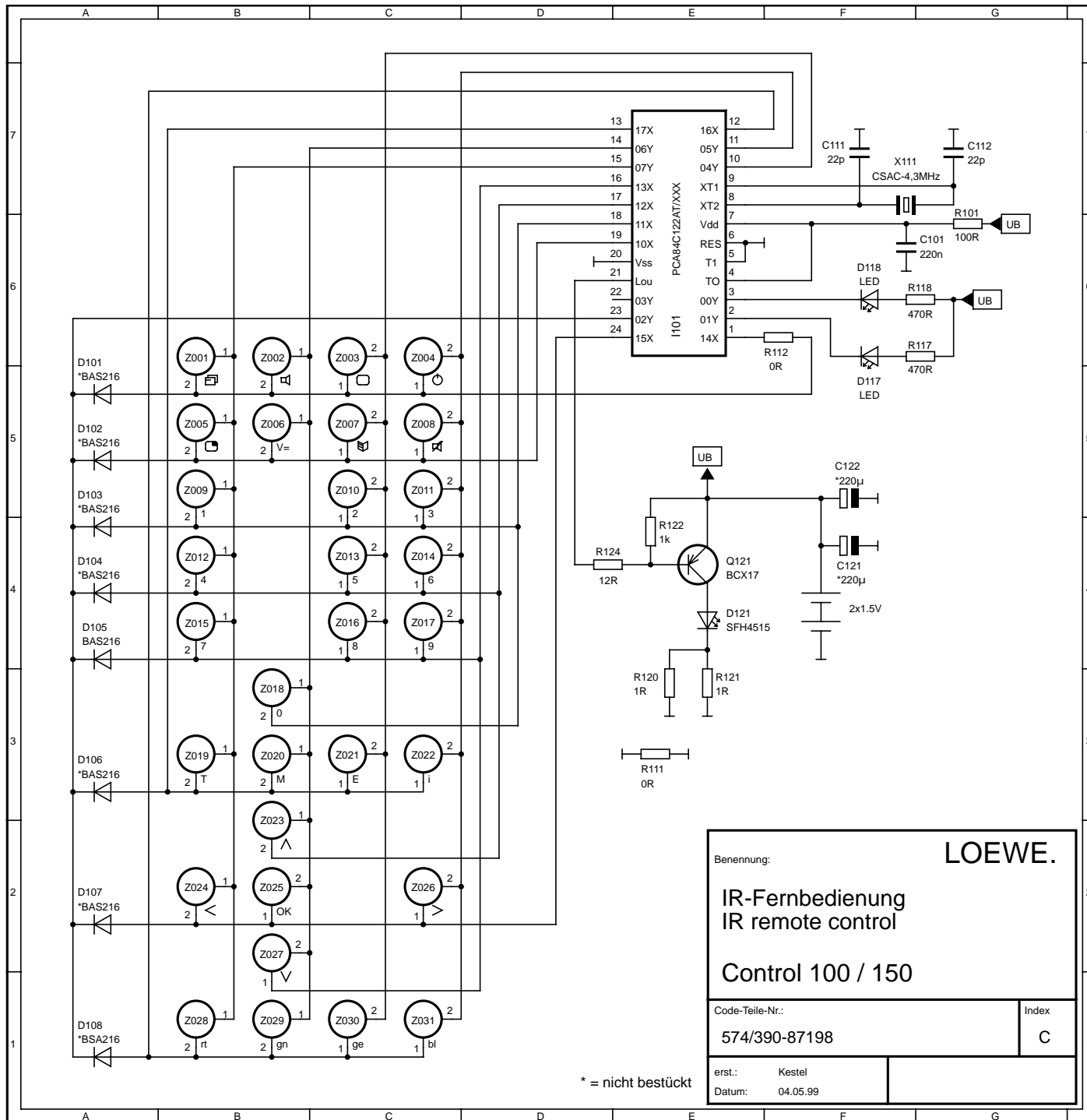

Benennung: **LOEWE.**

IR-Fernbedienung
IR remote control

Control 100 / 150

Code-Teile-Nr.:	Index
574/390-87198	C
erst.: Kestel	
Datum: 04.05.99	

* = nicht bestückt

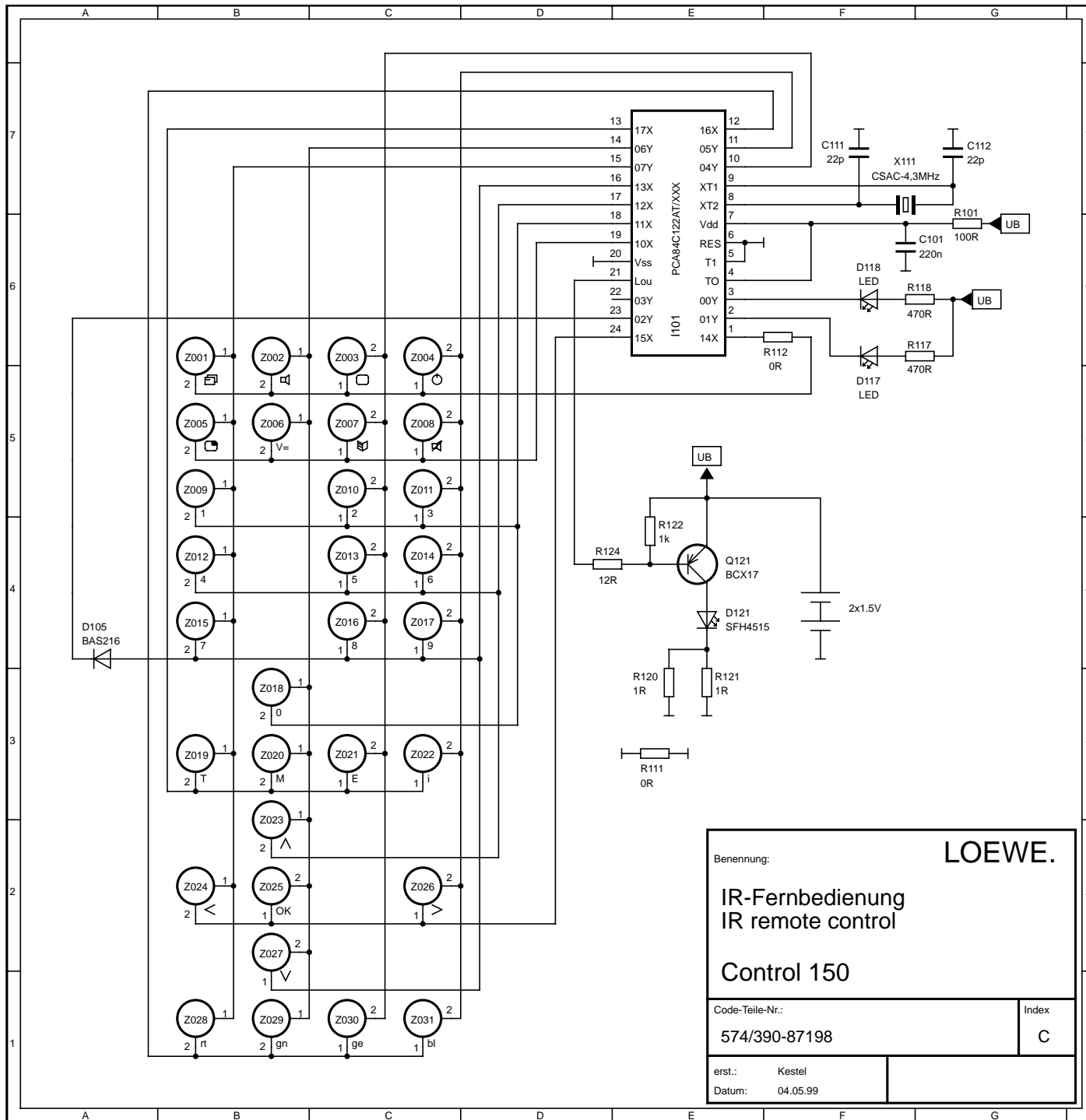

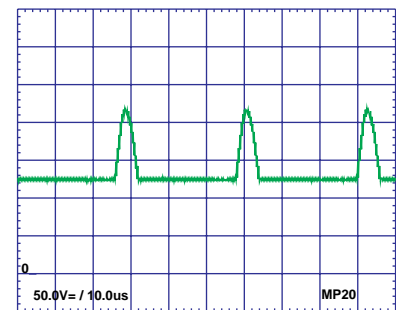
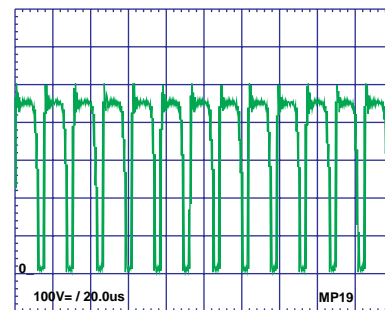
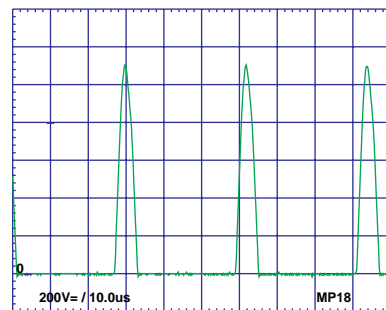
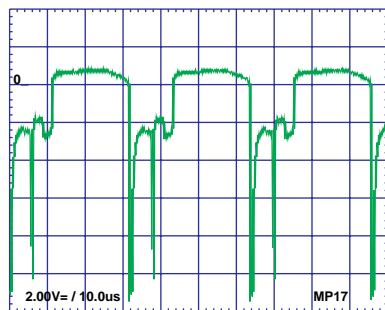
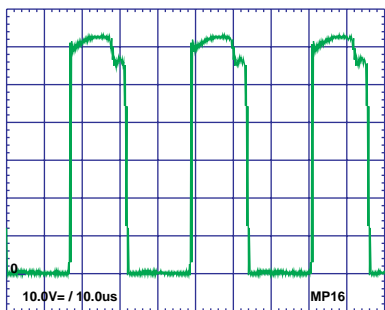
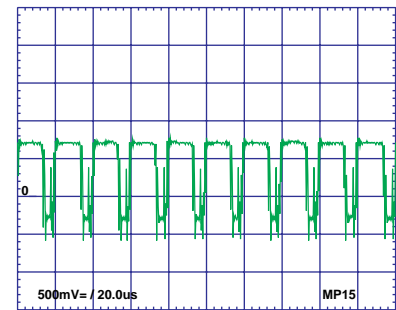
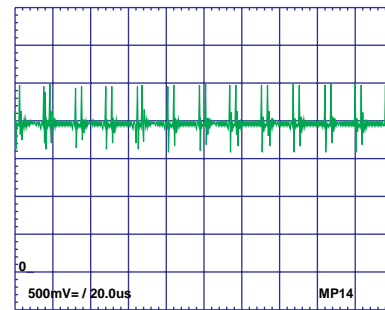
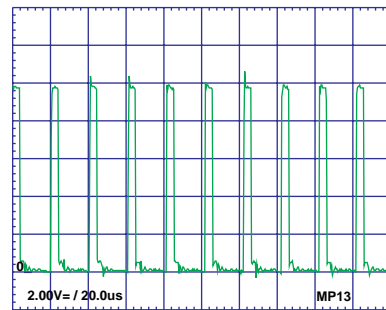
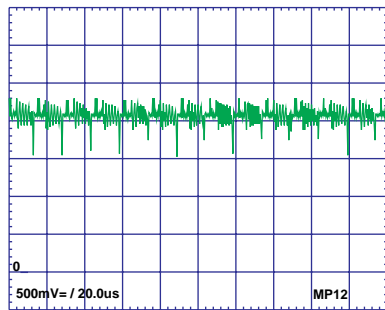
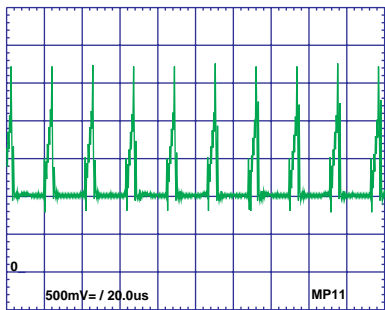
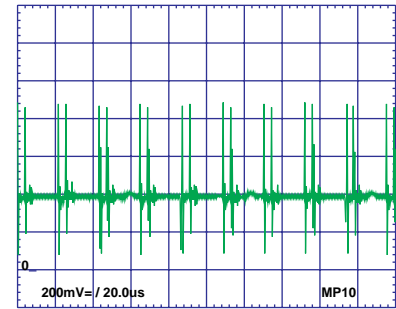
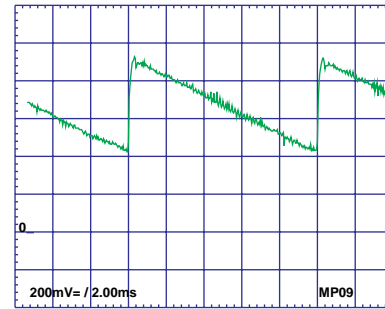
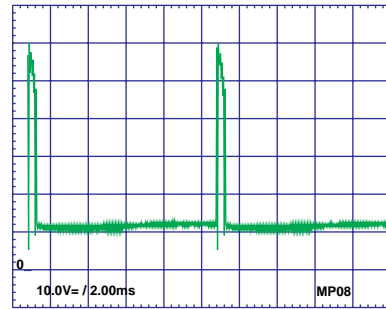
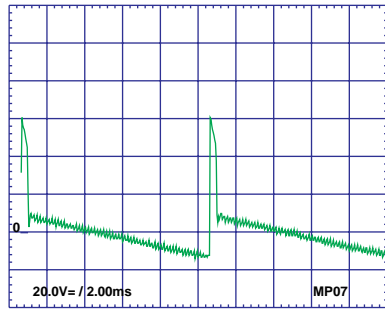
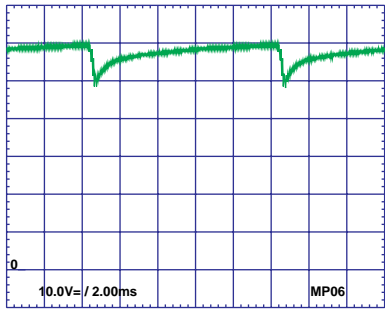
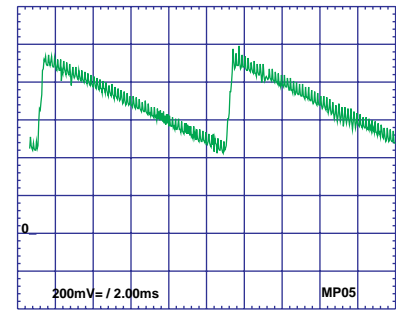
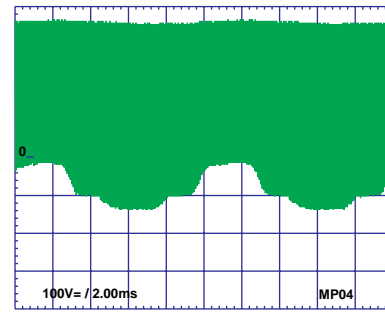
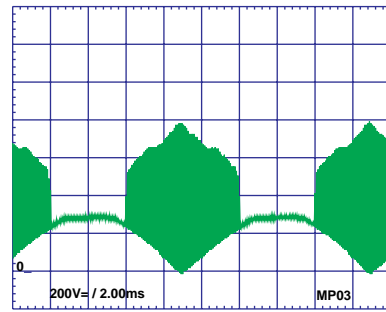
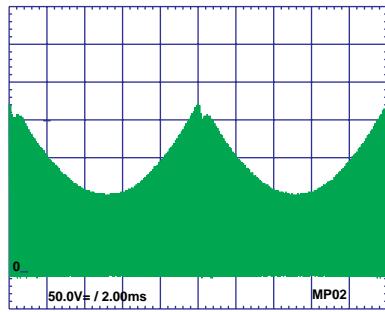
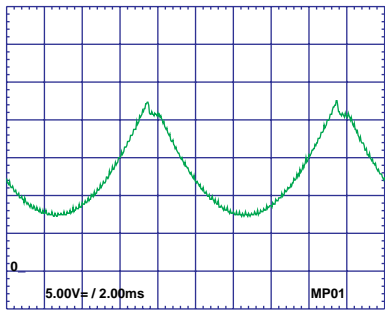

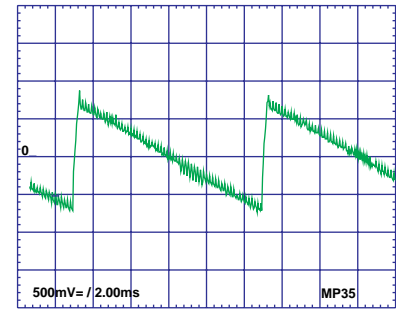
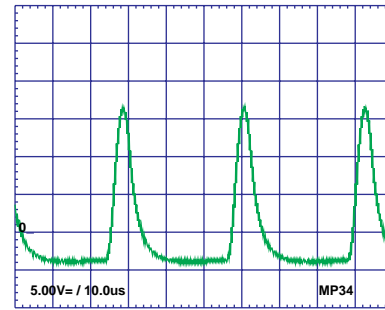
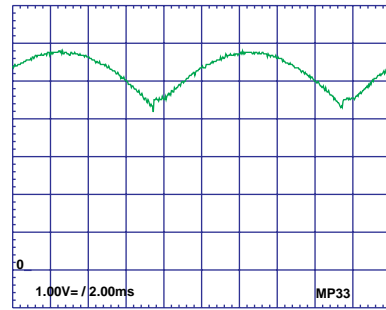
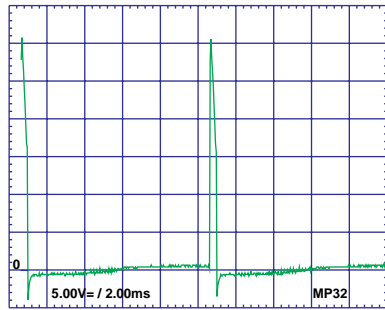
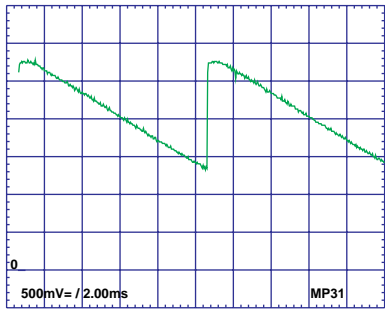
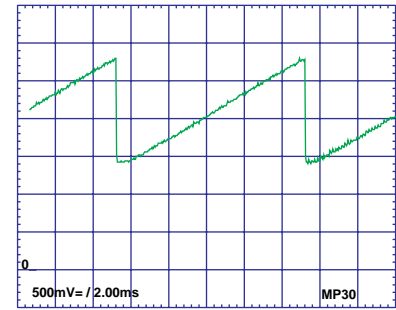
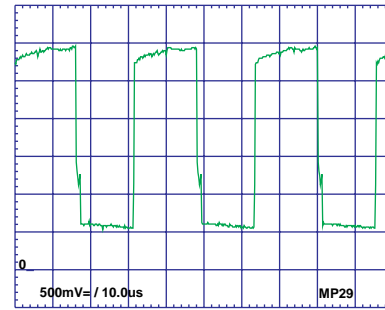
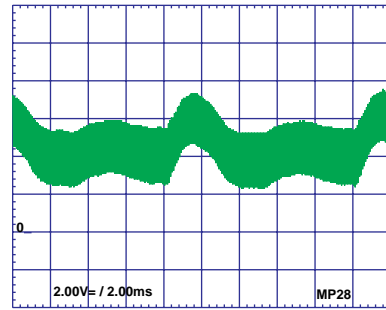
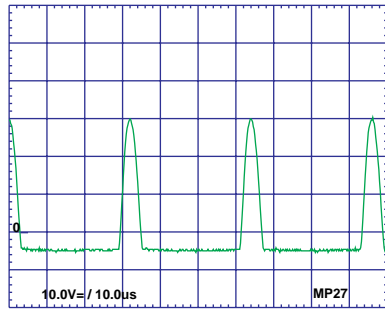
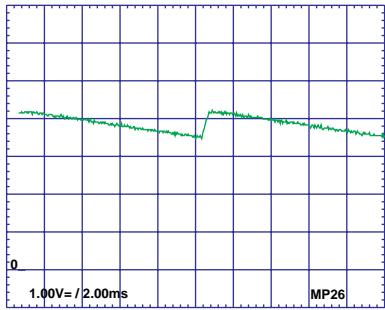
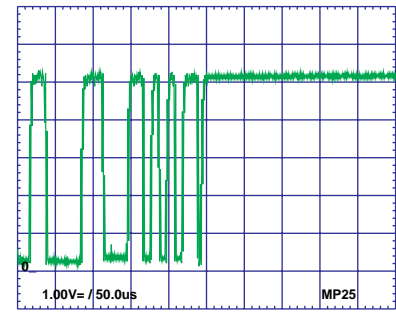
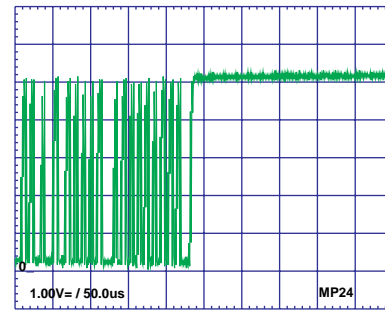
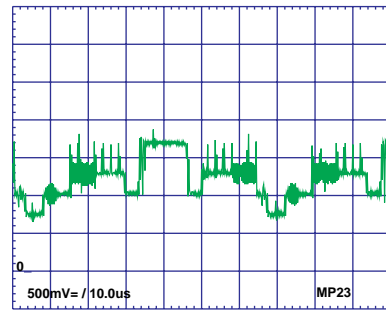
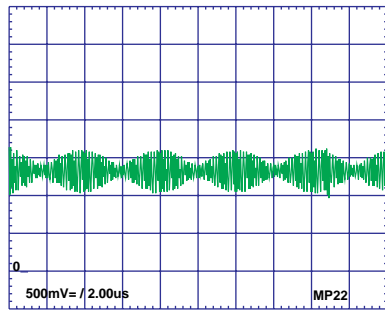
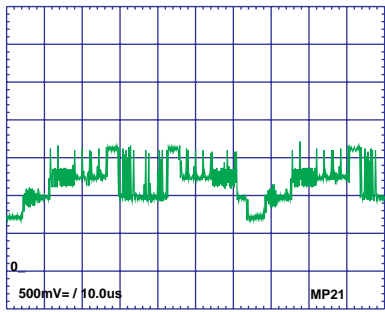

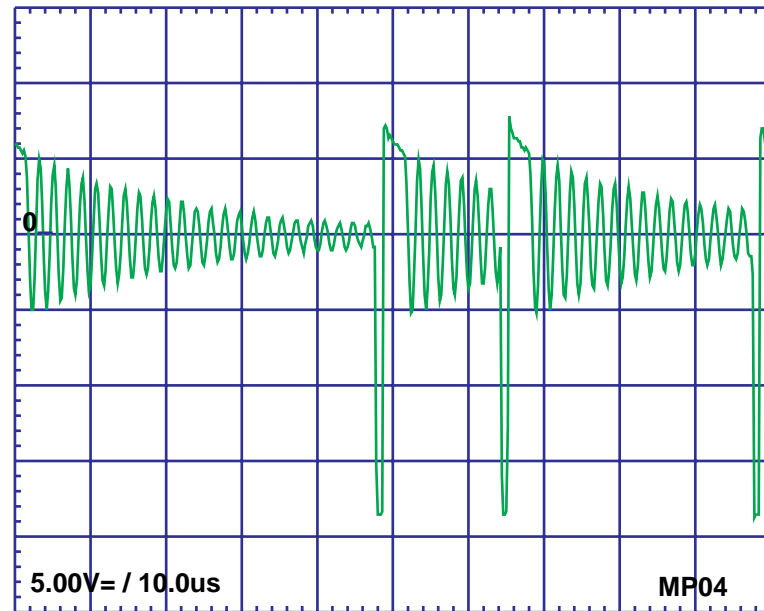
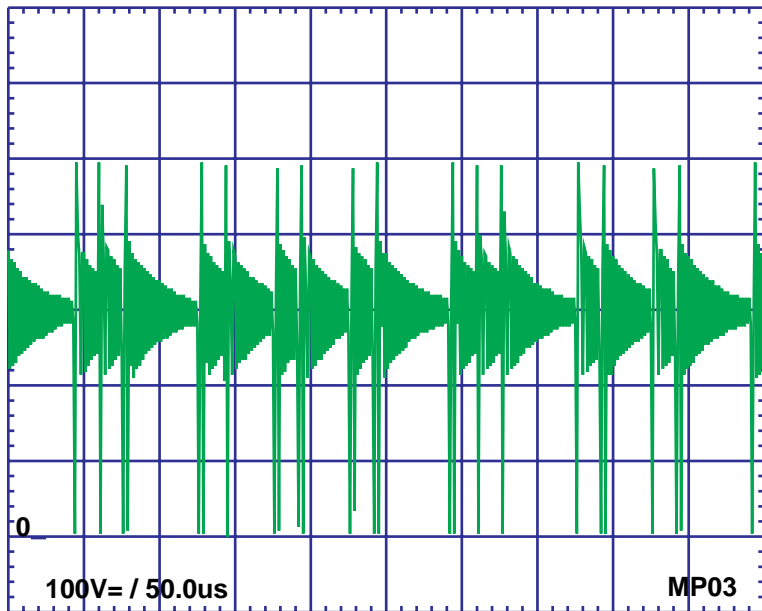
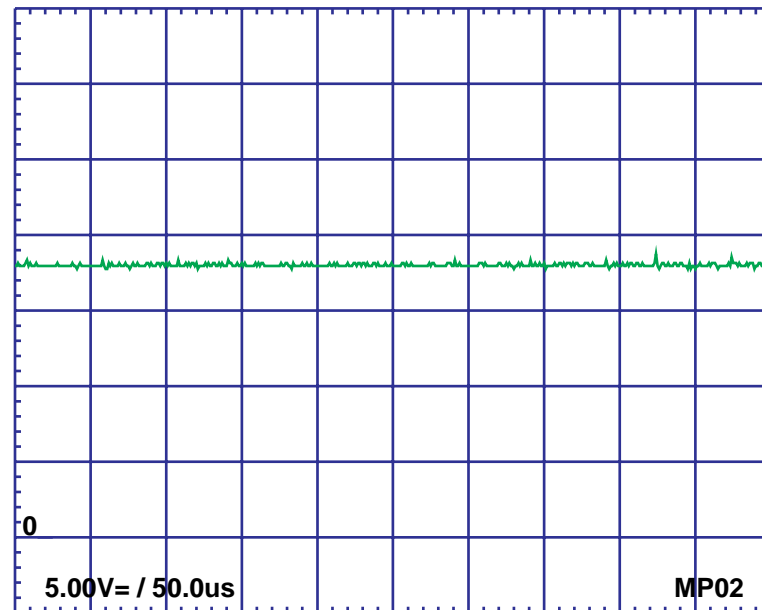
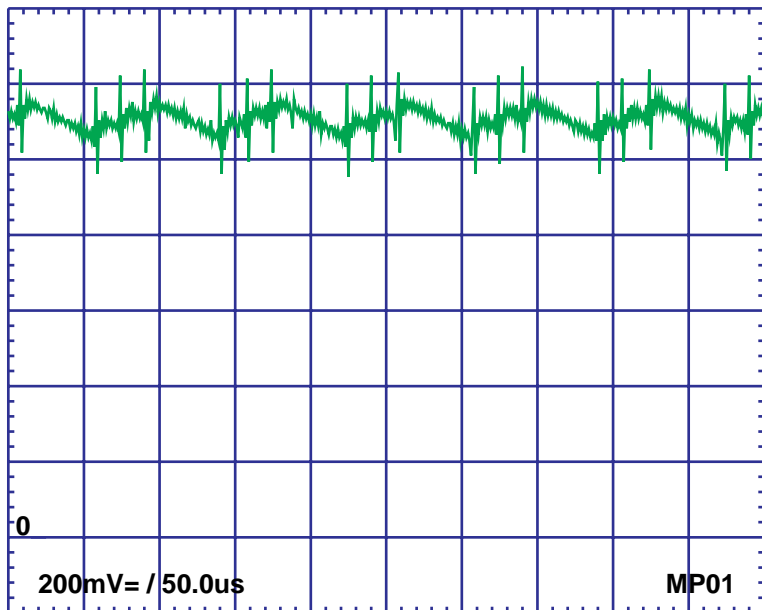

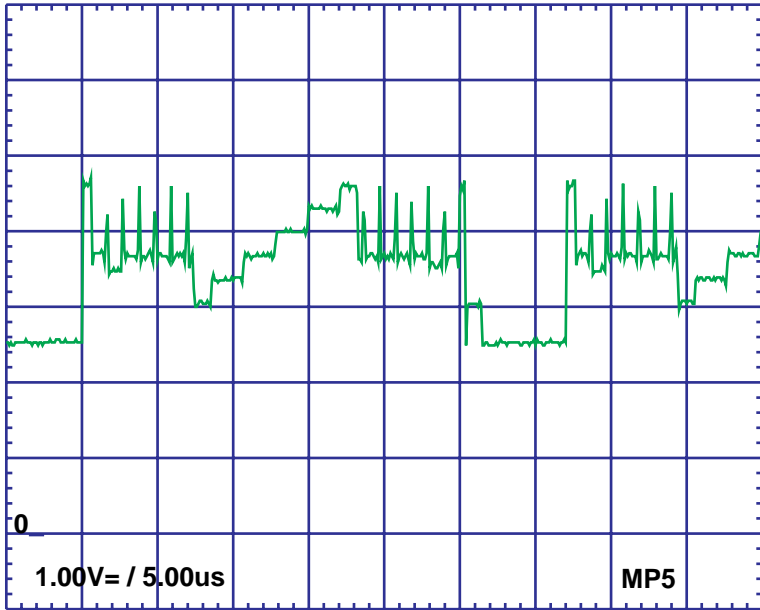
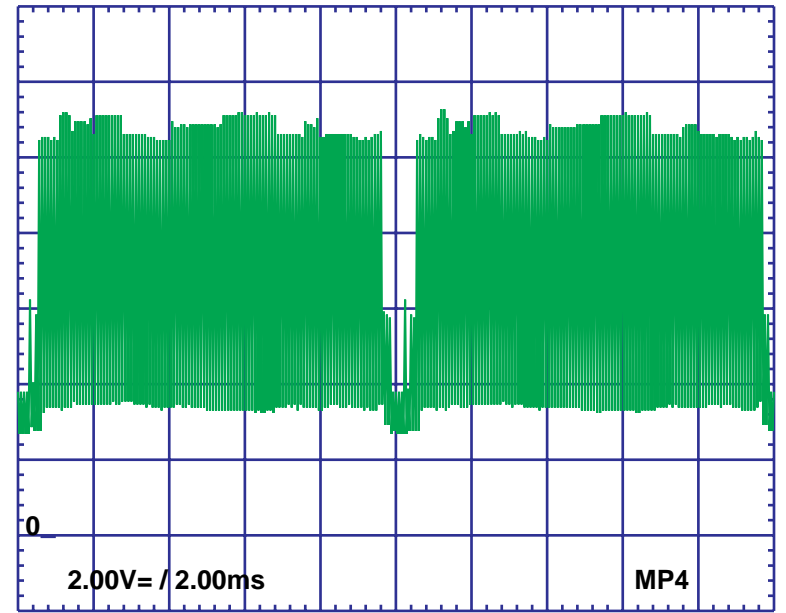
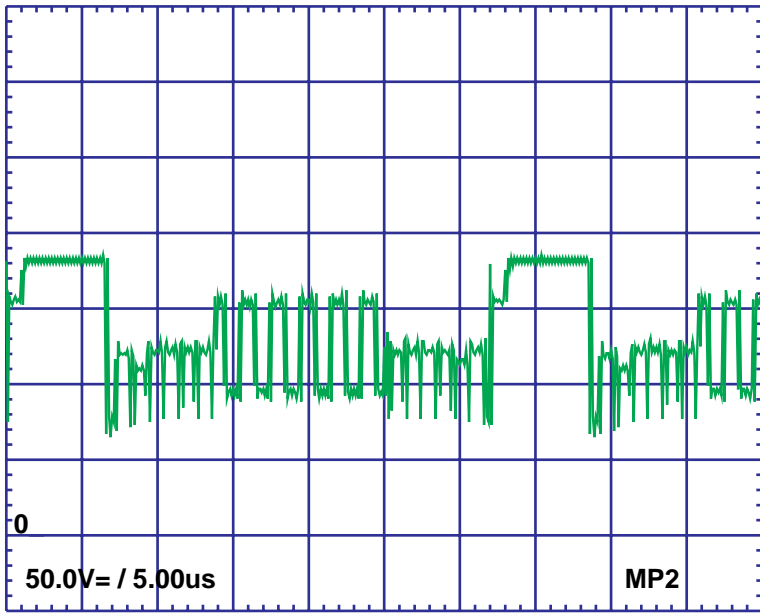

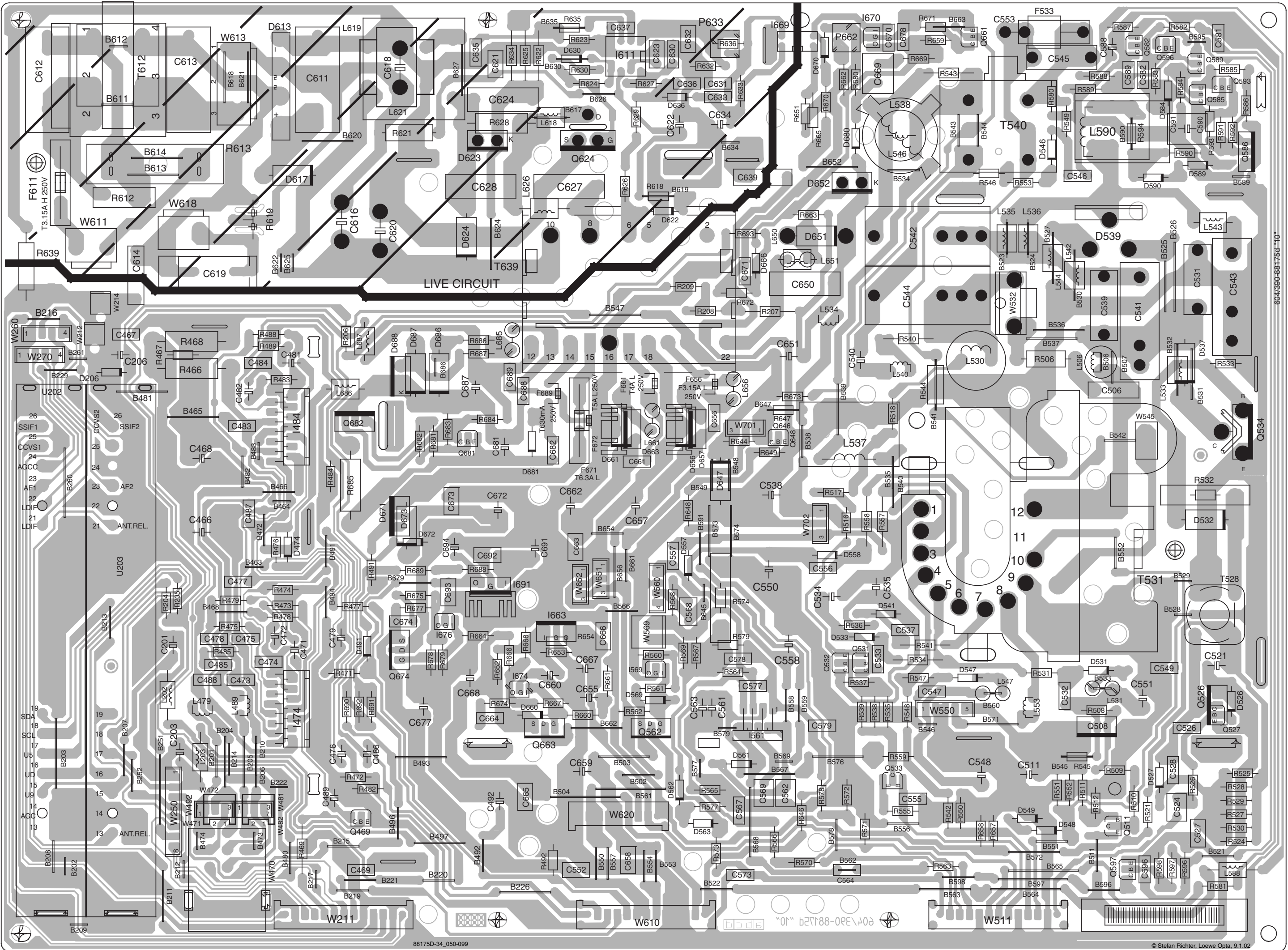

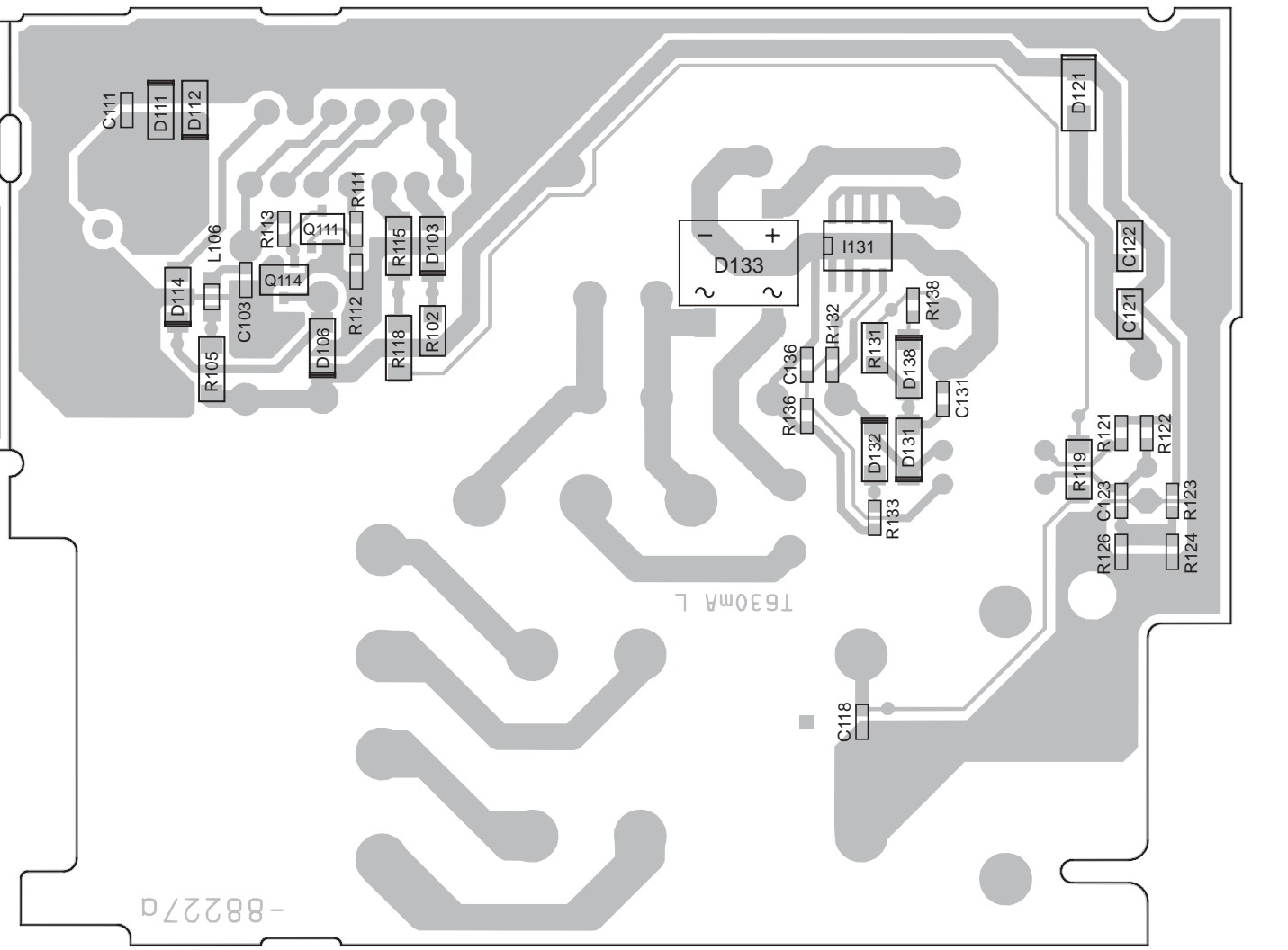
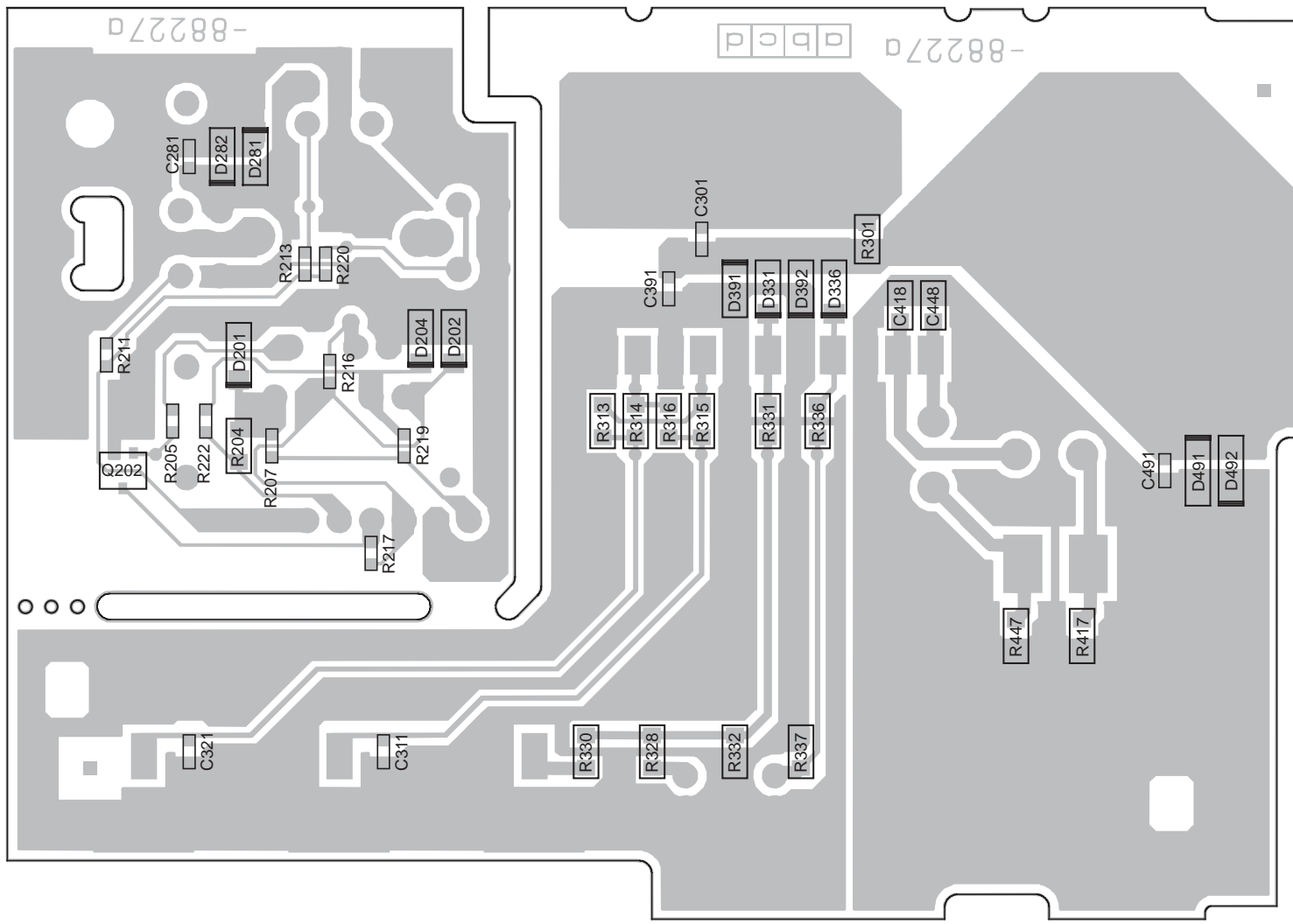
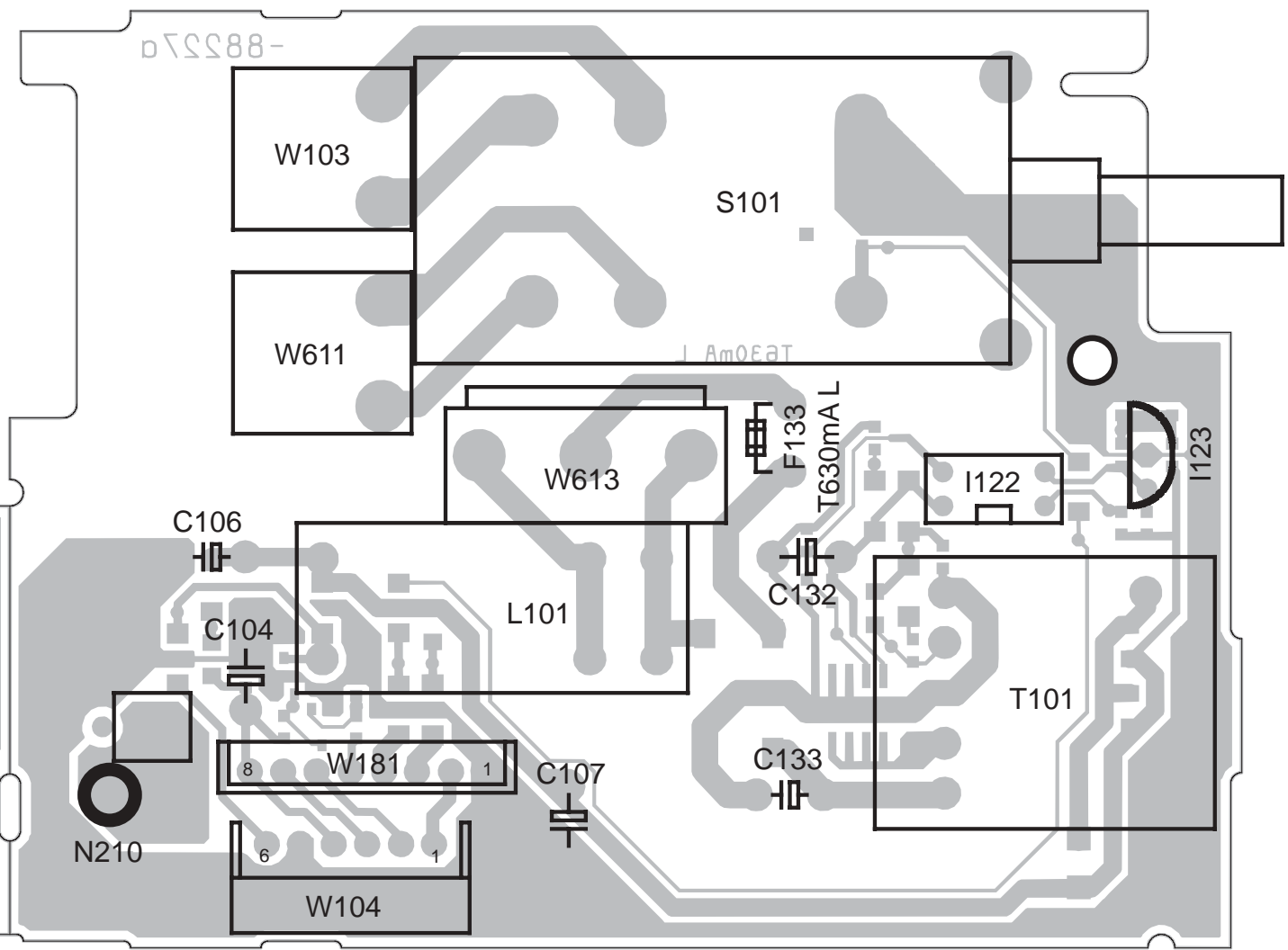
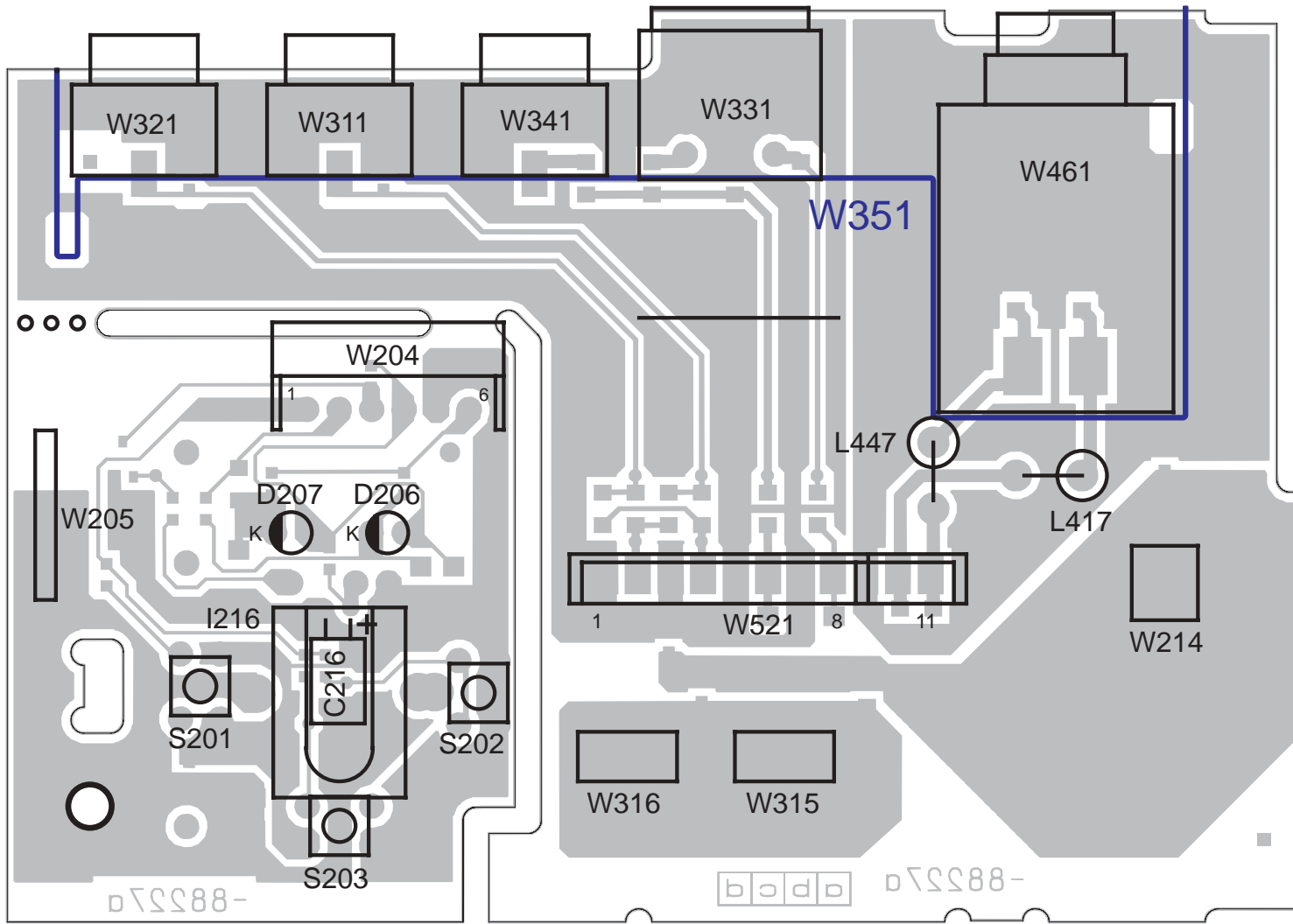

Ltpl. Bedienteil 88227A
 Bestückungsseite
 Control Unit P.C.B 88227A
 Components side

Ltpl. Bedienteil 88227A
 Lötseite
 Control Unit P.C.B 88227A
 Solder side

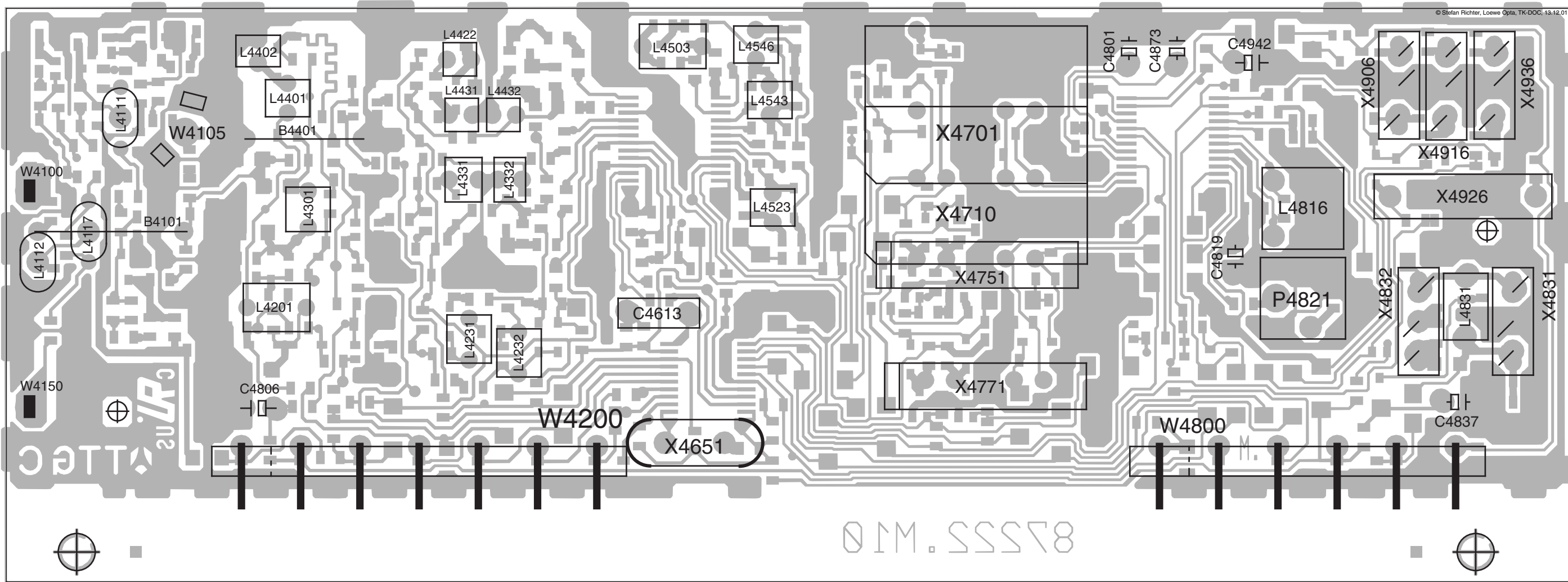

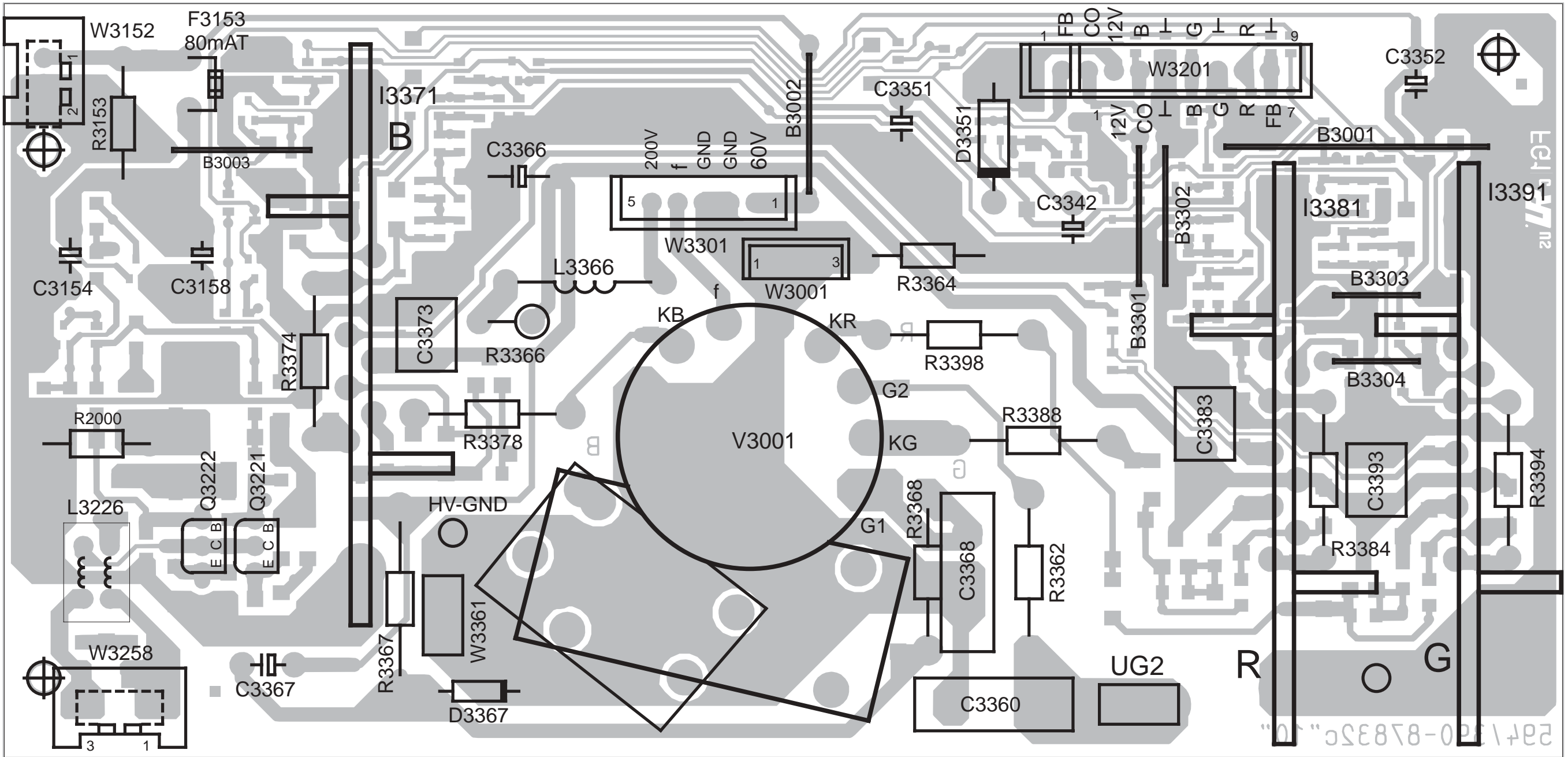

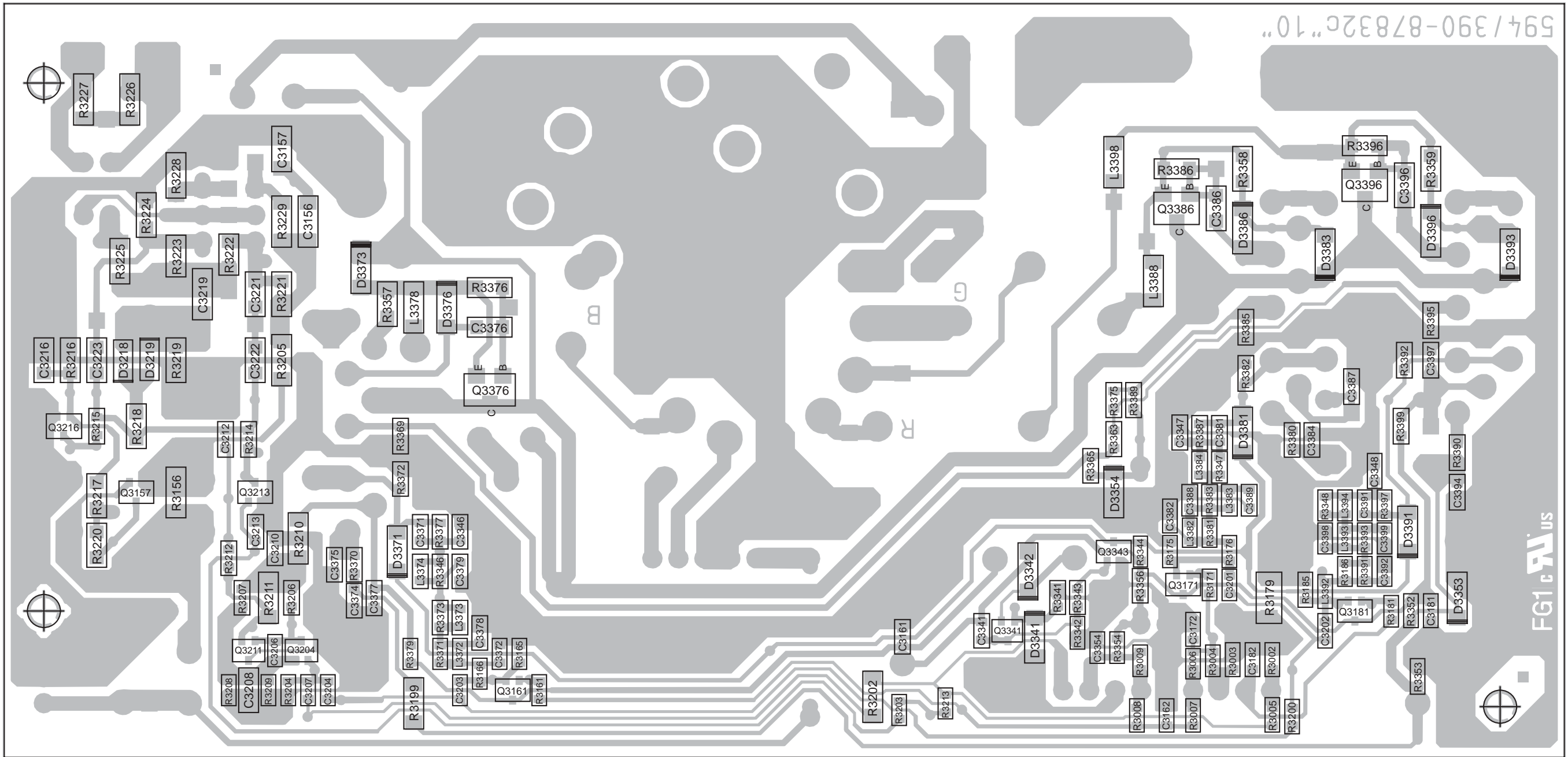

594/390-87832C"10"

FG1 c RA US

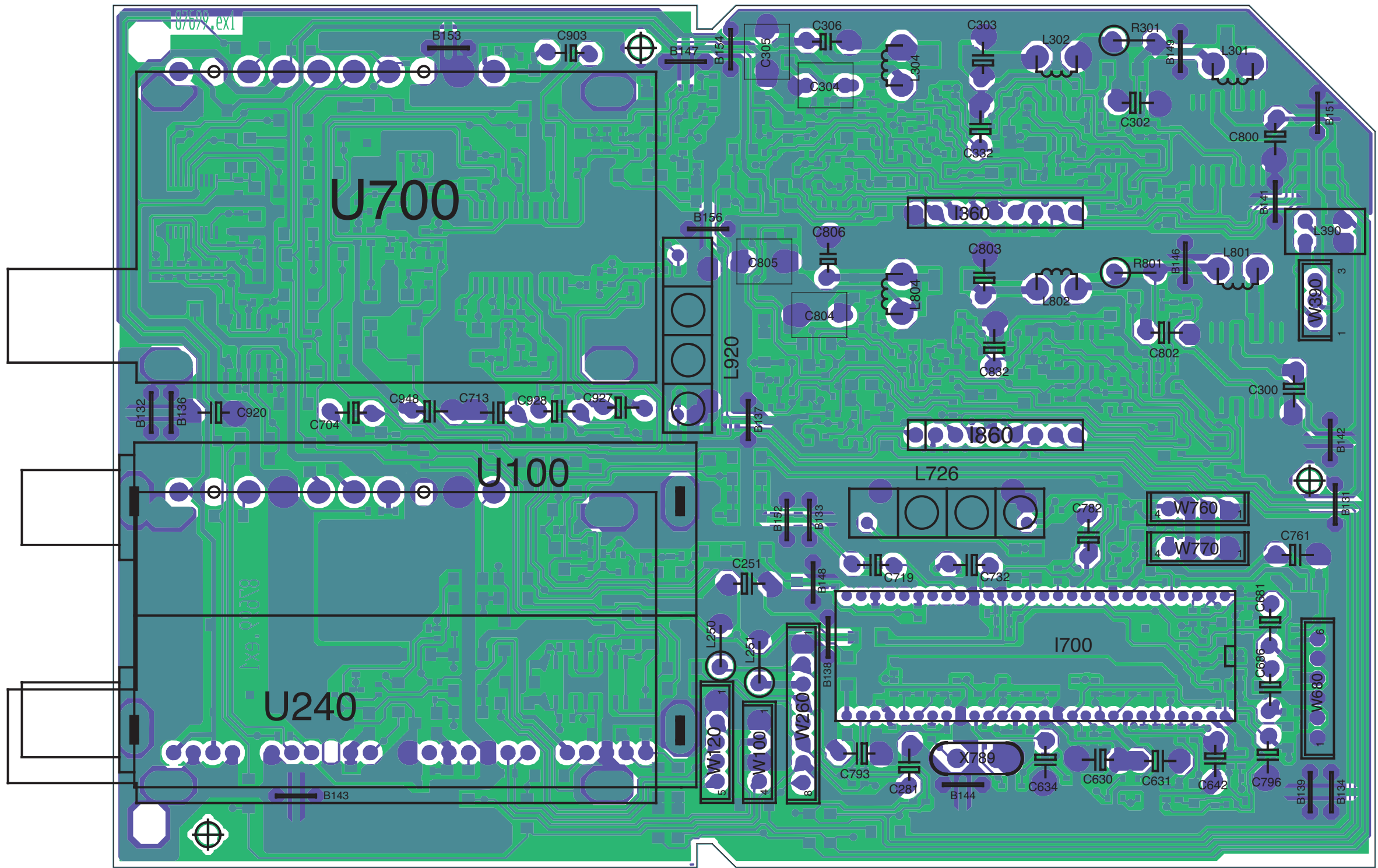

Leiterplatte SAT 6 87699E (Bestückungsseite)

SAT 6 P.C.B 87699E (Components side)

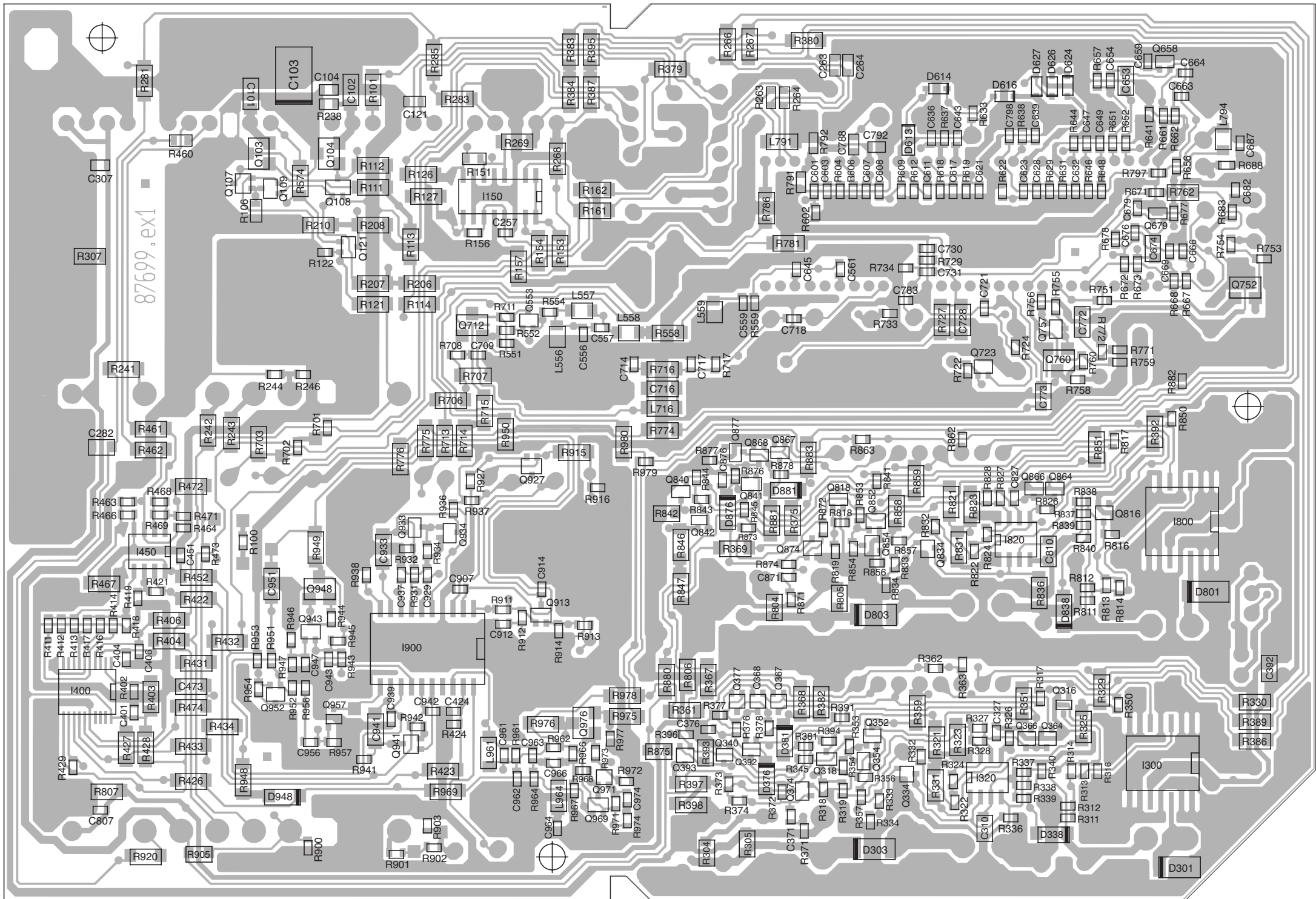

Leiterplatte SAT 6 87699E (Lötseite)

SAT 6 P.C.B 87699E (Solder side)

Basic-Board Basic Board Art.-Nr. 88175.055-099

Pos.Nr. Bestell-Bezeichnung Description Bestell-Nr. Var.
Item N°. List Part N°. Var.

BAUGRUPPEN		UNITS		
U202	Tuner-ZF M Multisystem MN/BG-DK	Tuner	260-87271.051	055
U202	Tuner-ZF M Multisystem MN/BG-DK	Tuner	260-87271.051	065
U202	Tuner-ZF M Multisystem MN/BG-DK	Tuner	260-87271.051	066
U202	Tuner-ZF M Multisystem MN/BG-DK	Tuner	260-87271.051	076
U202	Tuner-ZF M Multisystem MN/BG-DK	Tuner	260-87271.051	081
U202	Tuner-ZF M Multisystem MN/BG-DK	Tuner	260-87271.051	083
U202	Tuner-ZF M Multisystem MN/BG-DK	Tuner	260-87271.051	086
U202	Tuner-ZF M Multisystem MN/BG-DK	Tuner	260-87271.051	087
U202	Tuner-ZF M Multisystem MN/BG-DK	Tuner	260-87271.051	091
U202	Tuner-ZF M Multisystem MN/BG-DK	Tuner	260-87271.051	093
U202	Tuner-ZF M Multisystem MN/BG-DK	Tuner	260-87271.051	096
U202	Tuner-ZF M Multisystem MN/BG-DK	Tuner	260-87271.051	098
U202	Tuner-ZF M Multisystem MN/BG-DK	Tuner	260-87271.051	099
U202	Tuner-ZF D Dualsystem BG-DK	Tuner	260-87273.051	080
U202	Tuner-ZF D Dualsystem BG-DK	Tuner	260-87273.051	082
U202	Tuner-ZF D Dualsystem BG-DK	Tuner	260-87273.051	084
U202	Tuner-ZF D Dualsystem BG-DK	Tuner	260-87273.051	090
U202	Tuner-ZF D Dualsystem BG-DK	Tuner	260-87273.051	094
U202	Tuner-ZF D Dualsystem BG-DK	Tuner	260-87273.051	095
U202	Tuner-ZF D Dualsystem BG-DK	Tuner	260-87273.051	097
U202	Tuner-ZF D Dualsystem BG-DK	Tuner	260-87273.051	084
U202	Tuner-ZF D Dualsystem BG-DK	Tuner	260-87273.051	090
U202	Tuner-ZF D Dualsystem BG-DK	Tuner	260-87273.051	094
U202	Tuner-ZF D Dualsystem BG-DK	Tuner	260-87273.051	095
U202	Tuner-ZF D Dualsystem BG-DK	Tuner	260-87273.051	097
U203	Tuner-ZF EPAS Eurosys. mit Ant.-Splitter	Tuner	260-87998.050	055
U203	Tuner-ZF EPAS Eurosys. mit Ant.-Splitter	Tuner	260-87998.050	065
U203	Tuner-ZF EPAS Eurosys. mit Ant.-Splitter	Tuner	260-87998.050	066
U203	Tuner-ZF EPAS Eurosys. mit Ant.-Splitter	Tuner	260-87998.050	076
U203	Tuner-ZF EPAS Eurosys. mit Ant.-Splitter	Tuner	260-87998.050	080
U203	Tuner-ZF EPAS Eurosys. mit Ant.-Splitter	Tuner	260-87998.050	084
U203	Tuner-ZF EPAS Eurosys. mit Ant.-Splitter	Tuner	260-87998.050	086
U203	Tuner-ZF EPAS Eurosys. mit Ant.-Splitter	Tuner	260-87998.050	087
U203	Tuner-ZF EPAS Eurosys. mit Ant.-Splitter	Tuner	260-87998.050	090
U203	Tuner-ZF EPAS Eurosys. mit Ant.-Splitter	Tuner	260-87998.050	093

SPULEN/LAUTSPRECHER		COILS,SPEAKERS		
L202	Dr. 47U K SMCC FASTRON	Choke	298-16925	
L203	Dr. 4330 030 38100 VAL	Choke	298-14399	
L533	FE-Dr. 0U7 6x5	Choke	298-27471.Y03	
L534	DR-RA 150U K 10x15	Choke	298-79726.020	
L537	Spule 510U K SP-U15	Coil	297-14691	081
L538	LIN-Regler 4,6UH	Deflection Unit	278-24475	091
L538	LIN-Regler	Deflection Unit	278-26787	055

Basic-Board Basic Board Art.-Nr. 88175.055-099

Pos.Nr. Bestell-Bezeichnung Description Bestell-Nr. Var.
Item N°. List Part N°. Var.

SPULEN/LAUTSPRECHER		COILS,SPEAKERS		
L538	LIN-Regler	Deflection Unit	278-26787	080
L538	LIN-Regler	Deflection Unit	278-26787	082
L538	LIN-Regler	Deflection Unit	278-26787	083
L538	LIN-Regler	Deflection Unit	278-26787	086
L538	LIN-Regler	Deflection Unit	278-26981	081
L538	LIN-Regler 5,4UH	Deflection Unit	278-27544	066
L538	LIN-Regler 5,4UH	Deflection Unit	278-27544	076
L538	LIN-Regler 5,4UH	Deflection Unit	278-27544	084
L538	LIN-Regler 5,4UH	Deflection Unit	278-27544	087
L538	LIN-Regler 5,4UH	Deflection Unit	278-27544	090
L538	LIN-Regler 5,4UH	Deflection Unit	278-27544	093
L538	LIN-Regler 5,4UH	Deflection Unit	278-27544	094
L538	LIN-Regler 5,4UH	Deflection Unit	278-27544	095
L538	LIN-Regler 5,4UH	Deflection Unit	278-27544	096
L538	LIN-Regler 5,4UH	Deflection Unit	278-27544	097
L538	LIN-Regler 5,4UH	Deflection Unit	278-27544	098
L538	LIN-Regler 5,4UH	Deflection Unit	278-27544	099
L538	LIN-Regler 4,1UH	Deflection Unit	278-29038	065
L619	Dr. 820U	Choke	298-28785	
T528	Treiberspule	Coil	297-23664	055
T528	Treiberspule	Coil	297-23664	065
T528	Treiberspule	Coil	297-23664	066
T528	Treiberspule	Coil	297-23664	076
T528	Treiberspule	Coil	297-23664	080
T528	Treiberspule	Coil	297-23664	082
T528	Treiberspule	Coil	297-23664	083
T528	Treiberspule	Coil	297-23664	084
T528	Treiberspule	Coil	297-23664	086
T528	Treiberspule	Coil	297-23664	087
T528	Treiberspule	Coil	297-23664	090
T528	Treiberspule	Coil	297-23664	091
T528	Treiberspule	Coil	297-23664	093
T528	Treiberspule	Coil	297-23664	094
T528	Treiberspule	Coil	297-23664	095
T528	Treiberspule	Coil	297-23664	096
T528	Treiberspule	Coil	297-23664	097
T528	Treiberspule	Coil	297-23664	098
T528	Treiberspule	Coil	297-23664	099

Basic-Board		Basic Board		Art.-Nr. 88175.055-099	
Pos.Nr. Item N°.	Bestell-Bezeichnung	Description	Bestell-Nr. List Part N°.	Var. Var.	

ALLGEM. MECHAN. TEILE		COMMON MECHANICAL PARTS		
20	Aufsteckkühlkörper	Screening	509-27369	084
20	Aufsteckkühlkörper	Screening	509-27369	086
20	Aufsteckkühlkörper	Screening	509-27369	090
20	Aufsteckkühlkörper	Screening	509-27369	091
20	Aufsteckkühlkörper	Screening	509-27369	093
20	Aufsteckkühlkörper	Screening	509-27369	094
20	Aufsteckkühlkörper	Screening	509-27369	095
20	Aufsteckkühlkörper	Screening	509-27369	096
20	Aufsteckkühlkörper	Screening	509-27369	097
20	Aufsteckkühlkörper	Screening	509-27369	098
20	Aufsteckkühlkörper	Screening	509-27369	099
30	Linsenschraube AM 3x10 brüniert	Screw	432-74571	055
30	Linsenschraube AM 3x10 brüniert	Screw	432-74571	065
30	Linsenschraube AM 3x10 brüniert	Screw	432-74571	066
30	Linsenschraube AM 3x10 brüniert	Screw	432-74571	076
30	Linsenschraube AM 3x10 brüniert	Screw	432-74571	080
30	Linsenschraube AM 3x10 brüniert	Screw	432-74571	081
30	Linsenschraube AM 3x10 brüniert	Screw	432-74571	082
30	Linsenschraube AM 3x10 brüniert	Screw	432-74571	083
30	Linsenschraube AM 3x10 brüniert	Screw	432-74571	084
30	Linsenschraube AM 3x10 brüniert	Screw	432-74571	086
30	Linsenschraube AM 3x10 brüniert	Screw	432-74571	090
30	Linsenschraube AM 3x10 brüniert	Screw	432-74571	091
30	Linsenschraube AM 3x10 brüniert	Screw	432-74571	093
30	Linsenschraube AM 3x10 brüniert	Screw	432-74571	094
30	Linsenschraube AM 3x10 brüniert	Screw	432-74571	095
30	Linsenschraube AM 3x10 brüniert	Screw	432-74571	096
30	Linsenschraube AM 3x10 brüniert	Screw	432-74571	097
30	Linsenschraube AM 3x10 brüniert	Screw	432-74571	098
30	Linsenschraube AM 3x10 brüniert	Screw	432-74571	099
H 01	Sicherungshalter für SI 5x20	Fuseholder Spring	730-20061	
H 02	Sicherungshalter für SI 5x20	Fuseholder Spring	730-20061	
H474	Montageclip	Spring	739-87529.001	
H484	Montageclip	Spring	739-87529.001	
H534	Montageclip	Spring	739-87529.001	
H539	Montageclip	Spring	739-87529.001	
H560	Montageclip	Spring	739-87529.001	
H561	Montageclip	Spring	739-87529.001	

Basic-Board		Basic Board		Art.-Nr. 88175.055-099	
Pos.Nr. Item N°.	Bestell-Bezeichnung	Description	Bestell-Nr. List Part N°.	Var. Var.	

ALLGEM. MECHAN. TEILE		COMMON MECHANICAL PARTS		
H562	Glimmerscheibe 16x21	Insulating Piece	421-10881	
H586	Montageclip	Spring	739-87529.001	
H587	Glimmerscheibe 16x21	Insulating Piece	421-10881	
H621	Kabelhalter	Cable Binding	530-29601	
H623	Montageclip	Spring	739-87529.001	
H624	Montageclip	Spring	739-87529.001	
H625	Glimmerscheibe 16x21	Insulating Piece	421-10881	
H652	Montageclip	Spring	739-87529.001	
H663	Montageclip	Spring	739-87529.001	
H671	Montageclip	Spring	739-87529.001	
H674	Montageclip	Spring	739-87529.001	
INTEGR. SCHALTUNGEN		INTEGRATED CIRCUITS		
1	L7808ACV TO220	Integrated Circuit	349-21780	087
1	L7808 ACV	Integrated Circuit	349-21780.Y20	087
1	L78S09CV	Integrated Circuit	349-24013	087
1	L79S09CV	Integrated Circuit	349-24013.040	087
1	L78S09CV geschnitten	Integrated Circuit	349-24013.Y18	087
10	L7808 ACV	Integrated Circuit	349-21780.Y20	055
10	L7808 ACV	Integrated Circuit	349-21780.Y20	065
10	L7808 ACV	Integrated Circuit	349-21780.Y20	066
10	L7808 ACV	Integrated Circuit	349-21780.Y20	076
10	L7808 ACV	Integrated Circuit	349-21780.Y20	080
10	L7808 ACV	Integrated Circuit	349-21780.Y20	081
10	L7808 ACV	Integrated Circuit	349-21780.Y20	082
10	L7808 ACV	Integrated Circuit	349-21780.Y20	083
10	L7808 ACV	Integrated Circuit	349-21780.Y20	084
10	L7808 ACV	Integrated Circuit	349-21780.Y20	086
10	L7808 ACV	Integrated Circuit	349-21780.Y20	090
10	L7808 ACV	Integrated Circuit	349-21780.Y20	091
10	L7808 ACV	Integrated Circuit	349-21780.Y20	093
10	L7808 ACV	Integrated Circuit	349-21780.Y20	094
10	L7808 ACV	Integrated Circuit	349-21780.Y20	095
10	L7808 ACV	Integrated Circuit	349-21780.Y20	096
10	L7808 ACV	Integrated Circuit	349-21780.Y20	097
10	L7808 ACV	Integrated Circuit	349-21780.Y20	098
10	L7808 ACV	Integrated Circuit	349-21780.Y20	099
10	L78S09CV geschnitten	Integrated Circuit	349-24013.Y18	055
10	L78S09CV geschnitten	Integrated Circuit	349-24013.Y18	065

Basic-Board Basic Board Art.-Nr. 88175.055-099

Pos.Nr. Item N°.	Bestell-Bezeichnung	Description	Bestell-Nr. List Part N°.	Var. Var.
	INTEGR. SCHALTUNGEN	INTEGRATED CIRCUITS		
10	L78S09CV geschnitten	Integrated Circuit	349-24013.Y18	066
10	L78S09CV geschnitten	Integrated Circuit	349-24013.Y18	076
10	L78S09CV geschnitten	Integrated Circuit	349-24013.Y18	080
10	L78S09CV geschnitten	Integrated Circuit	349-24013.Y18	081
10	L78S09CV geschnitten	Integrated Circuit	349-24013.Y18	082
10	L78S09CV geschnitten	Integrated Circuit	349-24013.Y18	083
10	L78S09CV geschnitten	Integrated Circuit	349-24013.Y18	084
10	L78S09CV geschnitten	Integrated Circuit	349-24013.Y18	086
10	L78S09CV geschnitten	Integrated Circuit	349-24013.Y18	090
10	L78S09CV geschnitten	Integrated Circuit	349-24013.Y18	091
10	L78S09CV geschnitten	Integrated Circuit	349-24013.Y18	093
10	L78S09CV geschnitten	Integrated Circuit	349-24013.Y18	094
10	L78S09CV geschnitten	Integrated Circuit	349-24013.Y18	095
10	L78S09CV geschnitten	Integrated Circuit	349-24013.Y18	096
10	L78S09CV geschnitten	Integrated Circuit	349-24013.Y18	097
10	L78S09CV geschnitten	Integrated Circuit	349-24013.Y18	098
10	L78S09CV geschnitten	Integrated Circuit	349-24013.Y18	099
10	L78S09CV	Integrated Circuit	349-24013.Y22	084
I474	TDA7296	Integrated Circuit	349-28414	
I484	TDA7296	Integrated Circuit	349-28414	
I500	TDA5637 SOT340	Integrated Circuit	350-27278	080
I500	TDA5637 SOT340	Integrated Circuit	350-27278	090
I561	TDA8177	Integrated Circuit	349-26528	055
I561	TDA8177	Integrated Circuit	349-26528	066
I561	TDA8177	Integrated Circuit	349-26528	081
I561	TDA8177	Integrated Circuit	349-26528	082
I561	TDA8177	Integrated Circuit	349-26528	083
I561	TDA8177	Integrated Circuit	349-26528	084
I561	TDA8177	Integrated Circuit	349-26528	091
I561	TDA8177	Integrated Circuit	349-26528	093
I561	TDA8177	Integrated Circuit	349-26528	094
I561	TDA8177	Integrated Circuit	349-26528	095
I561	TDA8177	Integrated Circuit	349-26528	096
I561	TDA8177	Integrated Circuit	349-26528	097
I561	TDA8177	Integrated Circuit	349-26528	098
I561	TDA8177	Integrated Circuit	349-26528	099
I561	STV9379A HEPTAWATT Vert.-Ablenkung	Integrated Circuit	349-28945	076
I561	STV9379A HEPTAWATT Vert.-Ablenkung	Integrated Circuit	349-28945	087

Basic-Board Basic Board Art.-Nr. 88175.055-099

Pos.Nr. Item N°.	Bestell-Bezeichnung	Description	Bestell-Nr. List Part N°.	Var. Var.
	INTEGR. SCHALTUNGEN	INTEGRATED CIRCUITS		
I561	STV9379FA HEPTAWATT Vert.-Ablenkung	Integrated Circuit	349-29150	065
I561	STV9379FA HEPTAWATT Vert.-Ablenkung	Integrated Circuit	349-29150	080
I561	STV9379FA HEPTAWATT Vert.-Ablenkung	Integrated Circuit	349-29150	086
I561	STV9379FA HEPTAWATT Vert.-Ablenkung	Integrated Circuit	349-29150	090
I569	TL 431ACL P	Integrated Circuit	349-19817.020	
I600	TSA5523M SOT266	Integrated Circuit	350-27275	080
I600	TSA5523M SOT266	Integrated Circuit	350-27275	090
I611	TDA4605-3/TDA4605	Integrated Circuit	349-22113	
I663	L7808ACV vormontiert	Integrated Circuit	349-21780.050	
I669	Opto-Koppler DIP4 80V 50/80mA	Coupler	353-28638	
I670	TL 431ACL P	Integrated Circuit	349-19817.020	
I674	TL 431ACL P	Integrated Circuit	349-19817.020	
I676	TL 431ACL P	Integrated Circuit	349-19817.020	
I691	L78S09CV vormontiert	Integrated Circuit	349-24013.051	
I800	TDA9817 TS-SSOP24	Integrated Circuit	350-28929	080
I800	TDA9817 TS-SSOP24	Integrated Circuit	350-28929	090
	TRANSISTOREN	TRANSISTORS		
1	POWBIPO ISOW218 NPN 1500V 10A 50W	Transistor	346-25708	087
10	SILPOW TO220FP PNP 80V 3A 24W	Transistor	346-28633	055
Q469	BC547B TO92	Transistor	346-74983.020	055
Q469	BC547B TO92	Transistor	346-74983.020	076
Q469	BC547B TO92	Transistor	346-74983.020	080
Q469	BC547B TO92	Transistor	346-74983.020	084
Q469	BC547B TO92	Transistor	346-74983.020	086
Q469	BC547B TO92	Transistor	346-74983.020	087
Q469	BC547B TO92	Transistor	346-74983.020	094
Q526	SILPLAN TO92 NPN 100V 2A 1W	Transistor	346-20796.020	
Q531	ZTX712 E-LINE	Transistor	346-27659.020	
Q532	ZTX614 E-LINE	Transistor	346-27660.020	
Q533	BF422 TO92	Transistor	346-11562.020	
Q534	POWBIPO ISOW218 vormontiert	Transistor	346-25708.Y20	
Q562	POWMOS TO220FP NCH 50V 10A 30W	Transistor	346-18528	
Q582	BC556B	Transistor	346-74967.020	
Q585	BC547B TO92	Transistor	346-74983.020	
Q586	BD537 TO220A	Transistor	346-77764	
Q589	BC557B	Transistor	346-74878.020	
Q593	BC557B	Transistor	346-74878.020	
Q596	BC556B	Transistor	346-74967.020	

Basic-Board Basic Board Art.-Nr. 88175.055-099

Pos.Nr. Item N°.	Bestell-Bezeichnung	Description	Bestell-Nr. List Part N°.	Var. Var.
	DIODEN	DIODES		
D532	3,0A 200V DO201AD UFAST-GP	Diode	352-25838.Y10	090
D532	3,0A 200V DO201AD UFAST-GP	Diode	352-25838.Y10	091
D532	3,0A 200V DO201AD UFAST-GP	Diode	352-25838.Y10	093
D532	3,0A 200V DO201AD UFAST-GP	Diode	352-25838.Y10	094
D532	3,0A 200V DO201AD UFAST-GP	Diode	352-25838.Y10	095
D532	3,0A 200V DO201AD UFAST-GP	Diode	352-25838.Y10	096
D532	3,0A 200V DO201AD UFAST-GP	Diode	352-25838.Y10	097
D532	3,0A 200V DO201AD UFAST-GP	Diode	352-25838.Y10	098
D532	3,0A 200V DO201AD UFAST-GP	Diode	352-25838.Y10	099
D533	BA 157	Diode	352-44799	
D537	3,0A 40V DO27	Diode	352-12657.Y10	
D539	ESC011M	Diode	352-23667	
D541	BA 157	Diode	352-44799	
D546	BA 157	Diode	352-44799	
D547	BA 159	Diode	352-49148	
D548	1 N 4148 DO35	Diode	352-31818	
D549	ZD 30V0 2%	Diode	352-15763	
D551	DIOVC 0A02 30V SOD323 BB535	Diode	351-26570	080
D551	DIOVC 0A02 30V SOD323 BB535	Diode	351-26570	090
D557	1,0A 400V DO41 FAST-GP	Diode	352-20685	
D558	1,0A 400V DO41 FAST-GP	Diode	352-20685	
D561	BA 157	Diode	352-44799	
D569	ZD 12V0	Diode	352-44202	
D584	ZD 30V0 2%	Diode	352-15763	
D589	BA 157	Diode	352-44799	
D590	BA 157	Diode	352-44799	
D613	Gleichrichter B250 C3200/2200	Rectifier	354-22394	
D617	3,0A 1000V DO27A UFAST-GP	Diode	352-22712	
D622	BA 157	Diode	352-44799	
D623	STTA506F TO220	Diode	352-27866	
D636	BA 157	Diode	352-44799	
D651	3,0A 1000V DO27A UFAST-GP	Diode	352-22712	081
D652	BYT08PI-1000	Diode	352-28613	055
D652	BYT08PI-1000	Diode	352-28613	065
D652	BYT08PI-1000	Diode	352-28613	066
D652	BYT08PI-1000	Diode	352-28613	076
D652	BYT08PI-1000	Diode	352-28613	080
D652	BYT08PI-1000	Diode	352-28613	082

Basic-Board Basic Board Art.-Nr. 88175.055-099

Pos.Nr. Item N°.	Bestell-Bezeichnung	Description	Bestell-Nr. List Part N°.	Var. Var.
	DIODEN	DIODES		
D652	BYT08PI-1000	Diode	352-28613	083
D652	BYT08PI-1000	Diode	352-28613	084
D652	BYT08PI-1000	Diode	352-28613	086
D652	BYT08PI-1000	Diode	352-28613	087
D652	BYT08PI-1000	Diode	352-28613	090
D652	BYT08PI-1000	Diode	352-28613	091
D652	BYT08PI-1000	Diode	352-28613	093
D652	BYT08PI-1000	Diode	352-28613	094
D652	BYT08PI-1000	Diode	352-28613	095
D652	BYT08PI-1000	Diode	352-28613	096
D652	BYT08PI-1000	Diode	352-28613	097
D652	BYT08PI-1000	Diode	352-28613	098
D652	BYT08PI-1000	Diode	352-28613	099
D656	3,0A 300V DO201AD UFAST-GP	Diode	352-29726.Y10	
D660	ZD 12V0	Diode	352-44202	
D663	10,0A 200V vormontiert BYW-80	Diode	352-28625.050	
D666	0,5A 20V DO-35 SD103C	Diode	352-17741	
D670	ZD 30V0 2%	Diode	352-15763	
D671	STPS20L40CF ISOWATT220AB 2X10A	Diode	352-20296	
D672	ZD 3V9 DO35 5% 0,5W	Diode	352-10526	
D680	ZD 100V0 DO-41 J 1,3W ZPY	Diode	352-28686	
D681	BA 157	Diode	352-44799	055
D686	3,0A 200V DO201AD UFAST-GP	Diode	352-25838.Y10	
D687	3,0A 200V DO201AD UFAST-GP	Diode	352-25838.Y10	
D806	BAV 99W SOT323	Diode	351-27469	080
D806	BAV 99W SOT323	Diode	351-27469	090
	POTENTIOMETER	POTENTIOMETERS		
P662	POT 1K 6mm Kohleschicht horizont.	Potentiometer	375-22863.020	
	SICHERUNGEN	FUSES		
F611	3150mA T 250V 5x20 H	Fuse	380-29649	
F656	3150mA F 250V 8x8	Fuse	380-26219.020	
F661	4000mA T 250V 8x8	Fuse	380-13809.020	
F672	5000mA T 250V 8x8	Fuse	380-27665.020	
F689	630mA T 250V 8x8	Fuse	380-13837.020	055
	KONDENSATOREN	CAPACITORS		
C531	2N7 J 2000V	Capacitor	359-25292	055
C531	2N7 J 2000V	Capacitor	359-25292	065
C531	2N7 J 2000V	Capacitor	359-25292	066

Basic-Board Basic Board Art.-Nr. 88175.055-099

Pos.Nr. Item N°.	Bestell-Bezeichnung	Description	Bestell-Nr. List Part N°.	Var. Var.
---------------------	---------------------	-------------	------------------------------	--------------

KONDENSATOREN		CAPACITORS		
C543	25N J 630V	Capacitor	359-27012	087
C543	25N J 630V	Capacitor	359-27012	090
C543	25N J 630V	Capacitor	359-27012	093
C543	25N J 630V	Capacitor	359-27012	094
C543	25N J 630V	Capacitor	359-27012	095
C543	25N J 630V	Capacitor	359-27012	096
C543	25N J 630V	Capacitor	359-27012	097
C543	25N J 630V	Capacitor	359-27012	098
C543	25N J 630V	Capacitor	359-27012	099
C544	750N J 250V	Capacitor	359-16573	065
C544	750N J 250V	Capacitor	359-16573	093
C544	750N J 250V	Capacitor	359-16573	095
C544	750N J 250V	Capacitor	359-16573	096
C544	750N J 250V	Capacitor	359-16573	097
C544	750N J 250V	Capacitor	359-16573	098
C544	600N J 250V	Capacitor	359-24450	081
C544	680N J 250V	Capacitor	359-28116	055
C544	680N J 250V	Capacitor	359-28116	080
C544	680N J 250V	Capacitor	359-28116	082
C544	680N J 250V	Capacitor	359-28116	083
C544	680N J 250V	Capacitor	359-28116	086
C544	680N J 250V	Capacitor	359-28116	091
C544	900N J 160VW (250 V-)	Capacitor	359-73806	066
C544	900N J 160VW (250 V-)	Capacitor	359-73806	076
C544	900N J 160VW (250 V-)	Capacitor	359-73806	084
C544	900N J 160VW (250 V-)	Capacitor	359-73806	087
C544	900N J 160VW (250 V-)	Capacitor	359-73806	090
C544	900N J 160VW (250 V-)	Capacitor	359-73806	094
C544	900N J 160VW (250 V-)	Capacitor	359-73806	099
C545	390P J 2000V	Capacitor	359-28868	055
C545	390P J 2000V	Capacitor	359-28868	076
C545	390P J 2000V	Capacitor	359-28868	080
C545	390P J 2000V	Capacitor	359-28868	086
C545	390P J 2000V	Capacitor	359-28868	087
C545	390P J 2000V	Capacitor	359-28868	090
C546	470P K 1000V	Capacitor	357-23994.020	
C548	Elko 22U S 250V	Electrolytic Capacitor	360-11762.020	
C553	390P J 2000V	Capacitor	359-28868	055

Basic-Board Basic Board Art.-Nr. 88175.055-099

Pos.Nr. Item N°.	Bestell-Bezeichnung	Description	Bestell-Nr. List Part N°.	Var. Var.
---------------------	---------------------	-------------	------------------------------	--------------

KONDENSATOREN		CAPACITORS		
C553	390P J 2000V	Capacitor	359-28868	076
C553	390P J 2000V	Capacitor	359-28868	080
C553	390P J 2000V	Capacitor	359-28868	086
C553	390P J 2000V	Capacitor	359-28868	087
C553	390P J 2000V	Capacitor	359-28868	090
C561	Elko 22U S 250V	Electrolytic Capacitor	360-11762.020	065
C561	Elko 22U S 250V	Electrolytic Capacitor	360-11762.020	080
C561	Elko 22U S 250V	Electrolytic Capacitor	360-11762.020	086
C561	Elko 22U S 250V	Electrolytic Capacitor	360-11762.020	090
C568	470N J 100V	Capacitor	359-28078.020	
C579	470P K 1000V	Capacitor	357-23994.020	055
C579	470P K 1000V	Capacitor	357-23994.020	076
C579	470P K 1000V	Capacitor	357-23994.020	081
C579	470P K 1000V	Capacitor	357-23994.020	087
C611	470N M 275VW	Capacitor	359-28292	
C612	470N M 275VW	Capacitor	359-28292	084
C612	470N M 275VW	Capacitor	359-28292	087
C612	470N M 310VW	Capacitor	359-29681	055
C612	470N M 310VW	Capacitor	359-29681	065
C612	470N M 310VW	Capacitor	359-29681	066
C612	470N M 310VW	Capacitor	359-29681	076
C612	470N M 310VW	Capacitor	359-29681	080
C612	470N M 310VW	Capacitor	359-29681	081
C612	470N M 310VW	Capacitor	359-29681	082
C612	470N M 310VW	Capacitor	359-29681	083
C612	470N M 310VW	Capacitor	359-29681	084
C612	470N M 310VW	Capacitor	359-29681	086
C612	470N M 310VW	Capacitor	359-29681	090
C612	470N M 310VW	Capacitor	359-29681	091
C612	470N M 310VW	Capacitor	359-29681	093
C612	470N M 310VW	Capacitor	359-29681	094
C612	470N M 310VW	Capacitor	359-29681	095
C612	470N M 310VW	Capacitor	359-29681	096
C612	470N M 310VW	Capacitor	359-29681	097
C612	470N M 310VW	Capacitor	359-29681	098
C612	470N M 310VW	Capacitor	359-29681	099
C613	470N M 275VW	Capacitor	359-28292	084
C613	470N M 275VW	Capacitor	359-28292	087

Basic-Board Basic Board Art.-Nr. 88175.055-099**Pos.Nr. Bestell-Bezeichnung Description Bestell-Nr. Var.**
Item N°. List Part N°. Var.

	WIDERSTÄNDE	RESISTORS		
R468	470R J 0617 3,00W	Resistor	367-20648	
R475	4R7 K 0207 WIDSI	Resistor	366-18416	055
R475	4R7 K 0207 WIDSI	Resistor	366-18416	065
R475	4R7 K 0207 WIDSI	Resistor	366-18416	066
R475	4R7 K 0207 WIDSI	Resistor	366-18416	076
R475	4R7 K 0207 WIDSI	Resistor	366-18416	080
R475	4R7 K 0207 WIDSI	Resistor	366-18416	081
R475	4R7 K 0207 WIDSI	Resistor	366-18416	082
R475	4R7 K 0207 WIDSI	Resistor	366-18416	083
R475	4R7 K 0207 WIDSI	Resistor	366-18416	084
R475	4R7 K 0207 WIDSI	Resistor	366-18416	086
R475	4R7 K 0207 WIDSI	Resistor	366-18416	090
R475	4R7 K 0207 WIDSI	Resistor	366-18416	091
R475	4R7 K 0207 WIDSI	Resistor	366-18416	093
R475	4R7 K 0207 WIDSI	Resistor	366-18416	094
R475	4R7 K 0207 WIDSI	Resistor	366-18416	095
R475	4R7 K 0207 WIDSI	Resistor	366-18416	096
R475	4R7 K 0207 WIDSI	Resistor	366-18416	097
R475	4R7 K 0207 WIDSI	Resistor	366-18416	098
R475	4R7 K 0207 WIDSI	Resistor	366-18416	099
R477	10K F 0204	Resistor	367-20347	
R479	220R J 0207	Resistor	366-15679	
R485	4R7 K 0207 WIDSI	Resistor	366-18416	055
R485	4R7 K 0207 WIDSI	Resistor	366-18416	065
R485	4R7 K 0207 WIDSI	Resistor	366-18416	066
R485	4R7 K 0207 WIDSI	Resistor	366-18416	076
R485	4R7 K 0207 WIDSI	Resistor	366-18416	080
R485	4R7 K 0207 WIDSI	Resistor	366-18416	081
R485	4R7 K 0207 WIDSI	Resistor	366-18416	082
R485	4R7 K 0207 WIDSI	Resistor	366-18416	083
R485	4R7 K 0207 WIDSI	Resistor	366-18416	084
R485	4R7 K 0207 WIDSI	Resistor	366-18416	086
R485	4R7 K 0207 WIDSI	Resistor	366-18416	090
R485	4R7 K 0207 WIDSI	Resistor	366-18416	091
R485	4R7 K 0207 WIDSI	Resistor	366-18416	093
R485	4R7 K 0207 WIDSI	Resistor	366-18416	094
R485	4R7 K 0207 WIDSI	Resistor	366-18416	095
R485	4R7 K 0207 WIDSI	Resistor	366-18416	096

Basic-Board Basic Board Art.-Nr. 88175.055-099**Pos.Nr. Bestell-Bezeichnung Description Bestell-Nr. Var.**
Item N°. List Part N°. Var.

	WIDERSTÄNDE	RESISTORS		
R485	4R7 K 0207 WIDSI	Resistor	366-18416	097
R485	4R7 K 0207 WIDSI	Resistor	366-18416	098
R485	4R7 K 0207 WIDSI	Resistor	366-18416	099
R489	220R J 0207	Resistor	366-15679	
R491	3R3 K 0207 0,33W WIDSI	Resistor	366-11790	
R516	22R J 0207	Resistor	366-20655	
R517	22R J 0207	Resistor	366-20655	
R518	10R J 0207	Resistor	366-77101	
R521	3R3 K 0207 0,33W WIDSI	Resistor	366-11790	
R524	4K7 J 0207	Resistor	366-40343	
R525	4K7 J 0207	Resistor	366-40343	
R527	4K7 J 0207	Resistor	366-40343	
R528	4K7 J 0207	Resistor	366-40343	
R529	4K7 J 0207	Resistor	366-40343	
R530	4K7 J 0207	Resistor	366-40343	
R531	3R3 J 0207 0,50W WIDSI	Resistor	366-27701	
R532	1R2 K 4W	Resistor	368-11871	081
R532	0R68 K 4,00W	Resistor	368-21294	055
R532	0R68 J 4,00W	Resistor	368-21294	065
R532	0R68 J 4,00W	Resistor	368-21294	066
R532	0R68 K 4,00W	Resistor	368-21294	076
R532	0R68 K 4,00W	Resistor	368-21294	080
R532	0R68 J 4,00W	Resistor	368-21294	082
R532	0R68 J 4,00W	Resistor	368-21294	083
R532	0R68 K 4,00W	Resistor	368-21294	084
R532	0R68 K 4,00W	Resistor	368-21294	086
R532	0R68 K 4,00W	Resistor	368-21294	087
R532	0R68 J 4,00W	Resistor	368-21294	090
R532	0R68 J 4,00W	Resistor	368-21294	091
R532	0R68 J 4,00W	Resistor	368-21294	093
R532	0R68 K 4,00W	Resistor	368-21294	094
R532	0R68 J 4,00W	Resistor	368-21294	095
R532	0R68 J 4,00W	Resistor	368-21294	096
R532	0R68 J 4,00W	Resistor	368-21294	097
R532	0R68 J 4,00W	Resistor	368-21294	098
R532	0R68 J 4,00W	Resistor	368-21294	099
R533	12R F 0207	Resistor	367-21330	
R534	3R3 J 0207 0,50W WIDSI	Resistor	366-27701	

Basic-Board Basic Board Art.-Nr. 88175.055-099**Pos.Nr. Bestell-Bezeichnung Description Bestell-Nr. Var.**
Item N°. List Part N°. Var.

WIDERSTÄNDE		RESISTORS		
R535	100K J 0207	Resistor	366-16330	
R536	10K F 0204	Resistor	367-20347	
R537	10K F 0204	Resistor	367-20347	
R538	100K J 0207	Resistor	366-16330	
R539	100K J 0207	Resistor	366-16330	
R540	47R J 0411 0,75W WIDSI	Resistor	368-28118	
R541	3R3 J 0207 0,50W WIDSI	Resistor	366-27701	
R542	1K8 G 0204	Resistor	367-20334	
R543	1K5 J 0414 1W	Resistor	367-20657	
R544	2K2 K 0W5 0411	Resistor	367-29791	055
R544	2K2 K 0W5 0411	Resistor	367-29791	076
R544	2K2 K 0W5 0411	Resistor	367-29791	080
R544	2K2 K 0W5 0411	Resistor	367-29791	086
R544	2K2 K 0W5 0411	Resistor	367-29791	087
R544	2K2 K 0W5 0411	Resistor	367-29791	090
R544	2K2 K 0W5 0411	Resistor	367-29791	091
R544	2K2 K 0W5 0411	Resistor	367-29791	093
R544	2K2 K 0W5 0411	Resistor	367-29791	095
R544	2K2 K 0W5 0411	Resistor	367-29791	096
R545	3R3 J 0207 0,50W WIDSI	Resistor	366-27701	055
R545	3R3 J 0207 0,50W WIDSI	Resistor	366-27701	065
R545	3R3 J 0207 0,50W WIDSI	Resistor	366-27701	066
R545	3R3 J 0207 0,50W WIDSI	Resistor	366-27701	076
R545	3R3 J 0207 0,50W WIDSI	Resistor	366-27701	080
R545	3R3 J 0207 0,50W WIDSI	Resistor	366-27701	082
R545	3R3 J 0207 0,50W WIDSI	Resistor	366-27701	083
R545	3R3 J 0207 0,50W WIDSI	Resistor	366-27701	084
R545	3R3 J 0207 0,50W WIDSI	Resistor	366-27701	086
R545	3R3 J 0207 0,50W WIDSI	Resistor	366-27701	087
R545	3R3 J 0207 0,50W WIDSI	Resistor	366-27701	088
R545	3R3 J 0207 0,50W WIDSI	Resistor	366-27701	087
R545	3R3 J 0207 0,50W WIDSI	Resistor	366-27701	086
R545	3R3 J 0207 0,50W WIDSI	Resistor	366-27701	090
R545	3R3 J 0207 0,50W WIDSI	Resistor	366-27701	094
R545	3R3 J 0207 0,50W WIDSI	Resistor	366-27701	097
R545	3R3 J 0207 0,50W WIDSI	Resistor	366-27701	098
R545	3R3 J 0207 0,50W WIDSI	Resistor	366-27701	093
R545	3R3 J 0207 0,50W WIDSI	Resistor	366-27701	094
R545	3R3 J 0207 0,50W WIDSI	Resistor	366-27701	095
R545	3R3 J 0207 0,50W WIDSI	Resistor	366-27701	096
R545	3R3 J 0207 0,50W WIDSI	Resistor	366-27701	097
R545	3R3 J 0207 0,50W WIDSI	Resistor	366-27701	098
R545	3R3 J 0207 0,50W WIDSI	Resistor	366-27701	099

Basic-Board Basic Board Art.-Nr. 88175.055-099**Pos.Nr. Bestell-Bezeichnung Description Bestell-Nr. Var.**
Item N°. List Part N°. Var.

WIDERSTÄNDE		RESISTORS		
R546	220R J 0207	Resistor	366-15679	
R547	3R3 J 0207 0,50W WIDSI	Resistor	366-27701	
R549	150K G 0207	Resistor	367-10898	
R551	150K G 0207	Resistor	367-10898	
R553	220R J 0207	Resistor	366-15679	
R555	1K2 F 0204	Resistor	367-17324	
R557	1R0 J 0207 0,5W WIDSI	Resistor	366-28909	
R558	1R0 J 0207 0,5W WIDSI	Resistor	366-28909	
R559	33R K 0207 0,33W WIDSI	Resistor	367-29174.010	065
R559	33R K 0207 0,33W WIDSI	Resistor	367-29174.010	080
R559	33R K 0207 0,33W WIDSI	Resistor	367-29174.010	086
R559	33R K 0207 0,33W WIDSI	Resistor	367-29174.010	090
R560	10K F 0204	Resistor	367-20347	
R561	3K9 F 0204	Resistor	367-20341	
R563	470R J 0207	Resistor	366-20661	
R565	39K F 0204	Resistor	367-28894	
R566	82K G 0207	Resistor	367-10885	
R567	470R J 0207	Resistor	366-20661	055
R567	470R J 0207	Resistor	366-20661	065
R567	470R J 0207	Resistor	366-20661	066
R567	470R J 0207	Resistor	366-20661	076
R567	470R J 0207	Resistor	366-20661	080
R567	470R J 0207	Resistor	366-20661	082
R567	470R J 0207	Resistor	366-20661	083
R567	470R J 0207	Resistor	366-20661	084
R567	470R J 0207	Resistor	366-20661	086
R567	470R J 0207	Resistor	366-20661	087
R567	470R J 0207	Resistor	366-20661	090
R567	470R J 0207	Resistor	366-20661	094
R567	470R J 0207	Resistor	366-20661	097
R567	470R J 0207	Resistor	366-20661	098
R567	470R J 0207	Resistor	366-20661	099
R569	470R J 0207	Resistor	366-20661	
R570	15K G 0204	Resistor	367-14985	
R571	5K6 G 0204	Resistor	367-20343	
R572	5K6 G 0204	Resistor	367-20343	
R573	4K7 J 0207	Resistor	366-40343	
R574	0R82 K 4,00W	Resistor	368-11091	055

Basic-Board Basic Board Art.-Nr. 88175.055-099

Pos.Nr. Bestell-Bezeichnung Description Bestell-Nr. Var.
Item N°. List Part N°. Var.

WIDERSTÄNDE		RESISTORS		
R574	0R82 J 4,00W	Resistor	368-11091	091
R574	0R56 J 4W0	Resistor	368-11093	076
R574	0R56 J 4W0	Resistor	368-11093	087
R574	0R56 J 4W0	Resistor	368-11093	090
R574	0R56 K 0414	Resistor	368-21086	065
R574	0R56 K 0414	Resistor	368-21086	066
R574	0R56 K 0414	Resistor	368-21086	082
R574	0R56 K 0414	Resistor	368-21086	083
R574	0R56 K 0414	Resistor	368-21086	084
R574	0R56 K 0414	Resistor	368-21086	094
R574	0R56 K 0414	Resistor	368-21086	097
R574	0R56 K 0414	Resistor	368-21086	098
R574	0R56 K 0414	Resistor	368-21086	099
R574	0R68 K 4,00W	Resistor	368-21294	080
R574	0R68 K 4,00W	Resistor	368-21294	086
R574	1R J 2,00W	Resistor	368-22719	081
R574	1R J 2,00W	Resistor	368-22719	093
R574	1R J 2,00W	Resistor	368-22719	095
R574	1R J 2,00W	Resistor	368-22719	096
R578	82K G 0207	Resistor	367-10885	
R579	39K F 0204	Resistor	367-28894	
R581	10K F 0204	Resistor	367-20347	
R582	10K F 0204	Resistor	367-20347	
R583	220K F 0207	Resistor	367-28413	
R587	4K7 F 0204	Resistor	367-20346	
R588	10K F 0204	Resistor	367-20347	
R589	10K F 0204	Resistor	367-20347	
R590	10R J 0207	Resistor	366-77101	
R591	1R J 0207	Resistor	366-20649	
R592	1R J 0207	Resistor	366-20649	
R593	10R J 0207	Resistor	366-77101	
R594	1R K 0207 WIDSJ	Resistor	366-12276	
R596	100K J 0207	Resistor	366-16330	
R598	100K J 0207	Resistor	366-16330	
R613	1R5 K 7,00W	Resistor	368-24602	
R619	DUO-PTC-Wid. 18R	PTC Resistor	372-16662	066
R619	DUO-PTC-Wid. 18R	PTC Resistor	372-16662	082
R619	DUO-PTC-Wid. 18R	PTC Resistor	372-16662	083

Basic-Board Basic Board Art.-Nr. 88175.055-099

Pos.Nr. Bestell-Bezeichnung Description Bestell-Nr. Var.
Item N°. List Part N°. Var.

WIDERSTÄNDE		RESISTORS		
R619	DUO-PTC-Wid. 18R	PTC Resistor	372-16662	084
R619	DUO-PTC-Wid. 18R	PTC Resistor	372-16662	091
R619	DUO-PTC-Wid. 18R	PTC Resistor	372-16662	093
R619	DUO-PTC-Wid. 18R	PTC Resistor	372-16662	094
R619	DUO-PTC-Wid. 18R	PTC Resistor	372-16662	095
R619	DUO-PTC-Wid. 18R	PTC Resistor	372-16662	096
R619	DUO-PTC-Wid. 18R	PTC Resistor	372-16662	097
R619	DUO-PTC-Wid. 18R	PTC Resistor	372-16662	098
R619	DUO-PTC-Wid. 18R	PTC Resistor	372-16662	099
R619	DUO-PTC-Wid. 9R	PTC Resistor	372-28729	055
R619	DUO-PTC-Wid. 9R	PTC Resistor	372-28729	065
R619	DUO-PTC-Wid. 9R	PTC Resistor	372-28729	076
R619	DUO-PTC-Wid. 9R	PTC Resistor	372-28729	080
R619	DUO-PTC-Wid. 9R	PTC Resistor	372-28729	086
R619	DUO-PTC-Wid. 9R	PTC Resistor	372-28729	087
R619	DUO-PTC-Wid. 9R	PTC Resistor	372-28729	090
R619	DUO-PTC-Wid. 30R	PTC Resistor	372-73056	081
R621	56K J 0414 1,00W	Resistor	367-22396	
R622	820K J 0207	Resistor	366-16437	
R623	4K7 F 0204	Resistor	367-20346	
R625	680K J 0207	Resistor	367-27264	
R626	22R J 0207	Resistor	366-20655	
R627	10K F 0204	Resistor	367-20347	
R629	22R J 0207	Resistor	366-20655	
R634	680K J 0207	Resistor	367-27264	
R639	10M J 0414	Resistor	367-19664	
R651	18K G 0207	Resistor	367-11559	
R652	1R K 0207 WIDSJ	Resistor	366-12276	
R653	100R J 0207	Resistor	366-73257	
R654	100R J 0207	Resistor	366-73257	
R657	4K7 F 0204	Resistor	367-20346	
R658	4K7 F 0204	Resistor	367-20346	
R659	15K G 0204	Resistor	367-14985	065
R659	22K G 0204	Resistor	367-20331	055
R659	22K G 0204	Resistor	367-20331	066
R659	22K G 0204	Resistor	367-20331	076
R659	22K G 0204	Resistor	367-20331	080
R659	22K G 0204	Resistor	367-20331	081

Basic-Board Basic Board Art.-Nr. 88175.055-099

Pos.Nr. Bestell-Bezeichnung Description Bestell-Nr. Var.
Item N°. List Part N°. Var.

	WIDERSTÄNDE	RESISTORS		
R659	22K G 0204	Resistor	367-20331	082
R659	22K G 0204	Resistor	367-20331	083
R659	22K G 0204	Resistor	367-20331	084
R659	22K G 0204	Resistor	367-20331	086
R659	22K G 0204	Resistor	367-20331	087
R659	22K G 0204	Resistor	367-20331	090
R659	22K G 0204	Resistor	367-20331	091
R659	22K G 0204	Resistor	367-20331	093
R659	22K G 0204	Resistor	367-20331	094
R659	22K G 0204	Resistor	367-20331	095
R659	22K G 0204	Resistor	367-20331	096
R659	22K G 0204	Resistor	367-20331	097
R659	22K G 0204	Resistor	367-20331	098
R659	22K G 0204	Resistor	367-20331	099
R660	4K7 F 0204	Resistor	367-20346	
R661	4K7 F 0204	Resistor	367-20346	
R662	4K7 F 0204	Resistor	367-20346	
R663	220K F 0207	Resistor	367-28413	

Basic-Board Basic Board Art.-Nr. 88175.055-099

Pos.Nr. Bestell-Bezeichnung Description Bestell-Nr. Var.
Item N°. List Part N°. Var.

	WIDERSTÄNDE	RESISTORS		
R665	56K J 0414 1,00W	Resistor	367-22396	
R666	18K F 0204	Resistor	367-18527	
R668	4K7 F 0204	Resistor	367-20346	
R677	10K F 0204	Resistor	367-20347	
R678	10K F 0204	Resistor	367-20347	
R679	100K J 0207	Resistor	366-16330	
R681	3R3 J 0207	Resistor	366-77754	055
R682	33R J 0207	Resistor	366-22944	055
R683	470R J 0207	Resistor	366-20661	055
R684	6K8 J 0207	Resistor	366-20652	055
R685	68R J 3,00W RM20	Resistor	367-22942	055
R686	0R1 K 0207 WIDSI	Resistor	366-10905Y09	
R687	0R1 K 0207 WIDSI	Resistor	366-10905Y09	
R688	1R J 0207	Resistor	366-20649	
R689	1R J 0207	Resistor	366-20649	
R690	1R K 0207 WIDSI	Resistor	366-12276	
R691	100R J 0207	Resistor	366-73257	
R692	100R J 0207	Resistor	366-73257	
R693	220R J 0207	Resistor	366-15679	

Signal Board Q2500B

Art.-Nr. 88176.090-093

Pos.Nr. Item N°.	Bestell-Bezeichnung	Description	Bestell-Nr. List Part N°.	Var. Var.
	INTEGR. SCHALTUNGEN	INTEGRATED CIRCUITS		
10	M27V322-100XB1 PDIP42 100N OTP	Integrated Circuit	349-29779	091
I1711	TEA6415 SO20L	Integrated Circuit	350-25733	
I1731	TEA6415 SO20L	Integrated Circuit	350-25733	
I1771	HEF4053D SO16	Integrated Circuit	350-24881	
I1871	TEA6422D SO28	Integrated Circuit	350-25732	
I2051	MSP3400 PQFP-80 Sound	Integrated Circuit	350-29130	090
I2051	MSP3410 PQFP-80 Sound	Integrated Circuit	350-29131	091
I2051	MSP3411 PQFP-80 Sound	Integrated Circuit	350-29132	093
I2051	MSP3401 PQFP-80 Sound	Integrated Circuit	350-29133	092
I2056	MC 78L08ACP TO92	Integrated Circuit	349-24725.020	
I2091	MC33079 SO14	Integrated Circuit	350-28701	
I2271	VPC3230D MQFP80	Integrated Circuit	350-29177	092
I2271	VPC3230D MQFP80	Integrated Circuit	350-29177	093
I2271	VPC3231 QFP80 VIDEO	Integrated Circuit	350-29234	090
I2271	VPC3231 QFP80 VIDEO	Integrated Circuit	350-29234	091
I2311	SAA4979 QFP128 CONVER	Integrated Circuit	350-29128	
I2318	IC-VR 3V30 0A30 SOT223	Integrated Circuit	350-29462	
I2501	SDA9488 P-DSO28 PIP-IC	Integrated Circuit	350-29231	092
I2501	SDA9488 P-DSO28 PIP-IC	Integrated Circuit	350-29231	093
I2521	TDA9332H-N2 QFP-44 DEFLEC	Integrated Circuit	350-29481	
I2651	LM 358 SMD	Integrated Circuit	350-21521	
I2716	74HCT4052D SO16	Integrated Circuit	350-29463	
I2786	IC-VR 3V30 0A30 SOT223	Integrated Circuit	350-29462	
I2791	IC-VR 2V50 0A30 SOT223	Integrated Circuit	350-29460	
I2796	IC-VR 2V50 0A30 SOT223	Integrated Circuit	350-29460	
I2801	SDA6000 MQFP128 TELTEX	Integrated Circuit	350-29127	
I2906	48LC1M# TSOP 10NS SDRAM	Integrated Circuit	350-29138	
I2926	M27V160-100XB1 PDIP42 100N OTP	Integrated Circuit	349-29303	090
I2926	M27V160-100XB1 PDIP42 100N OTP	Integrated Circuit	349-29303	092
I2926	M27V160-100XB1 PDIP42 100N OTP	Integrated Circuit	349-29303	093
I2926	M27V322-100XB1 PDIP42 100N OTP	Integrated Circuit	349-29779	093
I2926	M27V322-100XB1OTP SW V1.2	Integrated Circuit	349-29779.483	091
I2931	24C64 DIP-8 EEPROM 64KB I2C	Integrated Circuit	349-28114	
I2941	ICRES 2V75 J SO8 TS831	Integrated Circuit	350-29141	
I2946	ICRES 2V75 J SO8 TS831	Integrated Circuit	350-29141	

Signal Board Q2500B

Art.-Nr. 88176.090-093

Pos.Nr. Item N°.	Bestell-Bezeichnung	Description	Bestell-Nr. List Part N°.	Var. Var.
	BUCHSEN/FASSUNGEN	SOCKETS		
11	Kurzschluß-Stecker	Plug	321-16821	092
11	Kurzschluß-Stecker	Plug	321-16821	093
H2926	IC-Fassung 42-pol. DIL	Socket	320-28410	
H2931	IC-Fassung 8-pol.	Socket	320-80503	
H2936	IC-Fassung 8-pol.	Socket	320-80503	
W1101	SCART-Buchse	Socket	323-19542	
W1201	SCART-Buchse	Socket	323-19542	
W1494	Cinch-Buchse 2-fach vertikal rot/weiß	Socket	323-28893	
W1941	Buchse vertikal Mini DIN 8-polig	Socket	323-28368	
	TRANSISTOREN	TRANSISTORS		
Q1142	BC847BW SOT323	Transistor	344-27272	
Q1152	BC857BW SOT323	Transistor	344-28404	
Q1161	BC817-25W SOT323	Transistor	344-28405	
Q1252	BC857BW SOT323	Transistor	344-28404	
Q1261	BC817-25W SOT323	Transistor	344-28405	
Q1432	BCW66H	Transistor	344-26051	
Q1433	BC857BW SOT323	Transistor	344-28404	
Q1446	BC857BW SOT323	Transistor	344-28404	
Q1453	BC847BW SOT323	Transistor	344-27272	
Q1461	BC847BW SOT323	Transistor	344-27272	
Q1473	BC847BW SOT323	Transistor	344-27272	
Q1483	BC857BW SOT323	Transistor	344-28404	
Q1491	BC847BW SOT323	Transistor	344-27272	
Q1493	BC847BW SOT323	Transistor	344-27272	
Q1496	BC847BW SOT323	Transistor	344-27272	
Q1498	BC847BW SOT323	Transistor	344-27272	
Q1581	BC847BW SOT323	Transistor	344-27272	
Q1586	BC847BW SOT323	Transistor	344-27272	
Q1773	BC847BW SOT323	Transistor	344-27272	
Q1776	BC857BW SOT323	Transistor	344-28404	
Q1782	BC857BW SOT323	Transistor	344-28404	
Q1784	BC857BW SOT323	Transistor	344-28404	
Q1792	BC847BW SOT323	Transistor	344-27272	
Q1814	BC847BW SOT323	Transistor	344-27272	
Q1834	BC847BW SOT323	Transistor	344-27272	092

Signal Board Q2500B

Art.-Nr. 88176.090-093

Pos.Nr. Item N°.	Bestell-Bezeichnung	Description	Bestell-Nr. List Part N°.	Var. Var.
	TRANSISTOREN	TRANSISTORS		
Q1834	BC847BW SOT323	Transistor	344-27272	093
Q1842	BC857BW SOT323	Transistor	344-28404	092
Q1842	BC857BW SOT323	Transistor	344-28404	093
Q1849	BC847BW SOT323	Transistor	344-27272	092
Q1849	BC847BW SOT323	Transistor	344-27272	093
Q1912	SN7002 SOT23 0A19 60V NCH	Transistor	344-29134	
Q1916	BC857BW SOT323	Transistor	344-28404	
Q1922	BSV52 SOT23	Transistor	344-16207	
Q1928	BC807-25 SOT23	Transistor	344-16064	
Q1931	BC857BW SOT323	Transistor	344-28404	
Q2027	BC857BW SOT323	Transistor	344-28404	
Q2076	BC857BW SOT323	Transistor	344-28404	
Q2078	BC857BW SOT323	Transistor	344-28404	
Q2081	BC857BW SOT323	Transistor	344-28404	
Q2083	BC857BW SOT323	Transistor	344-28404	
Q2226	BC857BW SOT323	Transistor	344-28404	
Q2371	BC847BW SOT323	Transistor	344-27272	
Q2472	BC857BW SOT323	Transistor	344-28404	
Q2482	BC857BW SOT323	Transistor	344-28404	
Q2486	BC847BW SOT323	Transistor	344-27272	
Q2492	BC857BW SOT323	Transistor	344-28404	
Q2496	BC847BW SOT323	Transistor	344-27272	
Q2556	BC847BW SOT323	Transistor	344-27272	
Q2561	BC847BW SOT323	Transistor	344-27272	
Q2581	BC847BW SOT323	Transistor	344-27272	
Q2612	BC847BW SOT323	Transistor	344-27272	
Q2616	BC847BW SOT323	Transistor	344-27272	
Q2623	BC857BW SOT323	Transistor	344-28404	
Q2626	BC857BW SOT323	Transistor	344-28404	
Q2628	BC857BW SOT323	Transistor	344-28404	
Q2638	BC847BW SOT323	Transistor	344-27272	
Q2639	BC847BW SOT323	Transistor	344-27272	
Q2721	BC847BW SOT323	Transistor	344-27272	
Q2726	BC847BW SOT323	Transistor	344-27272	
Q2731	BC847BW SOT323	Transistor	344-27272	
Q2737	BC847BW SOT323	Transistor	344-27272	
Q2755	BC847BW SOT323	Transistor	344-27272	
Q2758	BC847BW SOT323	Transistor	344-27272	

Signal Board Q2500B

Art.-Nr. 88176.090-093

Pos.Nr. Item N°.	Bestell-Bezeichnung	Description	Bestell-Nr. List Part N°.	Var. Var.
	TRANSISTOREN	TRANSISTORS		
Q2762	BC847BW SOT323	Transistor	344-27272	
Q2765	BC847BW SOT323	Transistor	344-27272	
Q2823	BC847BW SOT323	Transistor	344-27272	
Q2831	BC847BW SOT323	Transistor	344-27272	
Q2853	BC847BW SOT323	Transistor	344-27272	
Q2856	BC857BW SOT323	Transistor	344-28404	
Q2886	SN7002 SOT23 0A19 60V NCH	Transistor	344-29134	
Q2891	SN7002 SOT23 0A19 60V NCH	Transistor	344-29134	
Q2893	SN7002 SOT23 0A19 60V NCH	Transistor	344-29134	
Q2902	BC847BW SOT323	Transistor	344-27272	
Q2951	BC847BW SOT323	Transistor	344-27272	
Q2953	BC857BW SOT323	Transistor	344-28404	
Q2957	BC847BW SOT323	Transistor	344-27272	
Q2961	BC847BW SOT323	Transistor	344-27272	
	QUARZE/FILTER	QUARTZES		
X2048	18,432000 MHz HC49U	Crystal Oscillator	385-25502	
X2283	20,250000 MHz HC49U	Crystal Oscillator	385-26686	
X2336	12,000000 MHz HC49U CL=12PF	Crystal Oscillator	385-29247	
X2513	20,250000 MHz HC49U	Crystal Oscillator	385-26686	092
X2513	20,250000 MHz HC49U	Crystal Oscillator	385-26686	093
X2531	12,000000 MHz HC49U CL=12PF	Crystal Oscillator	385-29247	
X2876	6,000000 MHz HC49U CL=20PF	Crystal Oscillator	385-29248	
	WIDERSTÄNDE	RESISTORS		
R1168	10R J 0207 0,25W WIDSI	RESISTOR	366-20353	
R1268	10R J 0207 0,25W WIDSI	RESISTOR	366-20353	
R1711	10R J 0207 0,25W WIDSI	RESISTOR	366-20353	
R1731	10R J 0207 0,25W WIDSI	RESISTOR	366-20353	
R1780	10R J 0207 0,25W WIDSI	RESISTOR	366-20353	
R1811	10R J 0207 0,25W WIDSI	RESISTOR	366-20353	
R1871	10R J 0207 0,25W WIDSI	RESISTOR	366-20353	
R1929	10R J 0207 0,25W WIDSI	RESISTOR	366-20353	
	SMD TEILE	SMD PARTS		
D1237	ZD5V6 J 0W5 SOD-80 ZMM5.6	Diode	351-16758	
D1416	ZD5V6 J 0W5 SOD-80 ZMM5.6	Diode	351-16758	
D1564	ZD5V6 J 0W5 SOD-80 ZMM5.6	Diode	351-16758	
D1717	ZD5V6 J 0W5 SOD-80 ZMM5.6	Diode	351-16758	
D1919	Diode 0,2A 75V SOD80 LL4148	Diode	351-15015	
D1922	Diode 0,2A 75V SOD80 LL4148	Diode	351-15015	

Signal Board Q2500B

Art.-Nr. 88176.090-093

Pos.Nr. Item N°.	Bestell-Bezeichnung	Description	Bestell-Nr. List Part N°.	Var. Var.
	SMD TEILE	SMD PARTS		
D1931	Diode 0,2A 75V SOD80 LL4148	Diode	351-15015	
D1932	Diode 0,2A 75V SOD80 LL4148	Diode	351-15015	
D1937	ZD5V6 J 0W5 SOD-80 ZMM5.6	Diode	351-16758	
D1981	Diode 0,2A 75V SOD80 LL4148	Diode	351-15015	
D2031	ZD5V6 J 0W5 SOD-80 ZMM5.6	Diode	351-16758	
D2091	ZD12V0 J 0W5 SOD-80 ZMM12	Diode	351-17532	
D2092	ZD12V0 J 0W5 SOD-80 ZMM12	Diode	351-17532	
D2097	Diode 0,2A 75V SOD80 LL4148	Diode	351-15015	
D2549	Diode 0,2A 75V SOD80 LL4148	Diode	351-15015	
D2559	Diode 0,2A 75V SOD80 LL4148	Diode	351-15015	
D2567	Diode LL 103 C	Diode	351-16947	
D2572	ZD5V6 J 0W5 SOD-80 ZMM5.6	Diode	351-16758	
D2574	Diode LL 103 C	Diode	351-16947	
D2581	ZD20V0 J 0W5 SOD-80 ZMM20	Diode	351-22138	
D2582	Diode 0,2A 75V SOD80 LL4148	Diode	351-15015	
D2586	Diode 0,2A 75V SOD80 LL4148	Diode	351-15015	
D2591	Diode 0,2A 75V SOD80 LL4148	Diode	351-15015	
D2592	Diode 0,2A 75V SOD80 LL4148	Diode	351-15015	
D2594	Diode 0,2A 75V SOD80 LL4148	Diode	351-15015	
D2596	Diode LL 103 C	Diode	351-16947	
D2607	ZD20V0 J 0W5 SOD-80 ZMM20	Diode	351-22138	
D2611	Diode 0,2A 75V SOD80 LL4148	Diode	351-15015	
D2618	Diode 0,2A 75V SOD80 LL4148	Diode	351-15015	
D2631	Diode LL 103 C	Diode	351-16947	
D2632	Diode LL 103 C	Diode	351-16947	
D2657	Diode 0,2A 75V SOD80 LL4148	Diode	351-15015	
D2661	Diode 0,2A 75V SOD80 LL4148	Diode	351-15015	
D2667	Diode 0,2A 75V SOD80 LL4148	Diode	351-15015	
D2735	Diode 0,2A 75V SOD80 LL4148	Diode	351-15015	
D2781	Diode LL 103 C	Diode	351-16947	
D2783	Diode LL 103 C	Diode	351-16947	
D2856	Diode 0,2A 75V SOD80 LL4148	Diode	351-15015	
D2857	Diode LL 103 C	Diode	351-16947	
D2930	ZD5V6 G 0W5 SOD-80 ZMM5.6	Diode	351-22580	
D2964	Diode 0,2A 75V SOD80 LL4148	Diode	351-15015	
D2967	Diode 0,2A 75V SOD80 LL4148	Diode	351-15015	
Q1158	BC847BW SOT323	Transistor	344-27272	
Q1258	BC847BW SOT323	Transistor	344-27272	

Signal Board Q2500B

Art.-Nr. 88176.090-093

Pos.Nr. Item N°.	Bestell-Bezeichnung	Description	Bestell-Nr. List Part N°.	Var. Var.
	SMD TEILE	SMD PARTS		
Q1441	BC847BW SOT323	Transistor	344-27272	
Q1466	BC857BW SOT323	Transistor	344-28404	
Q1771	BC847BW SOT323	Transistor	344-27272	
Q1824	BC847BW SOT323	Transistor	344-27272	
Q2476	BC847BW SOT323	Transistor	344-27272	
Q2594	BC847BW SOT323	Transistor	344-27272	
Q2671	BC847BW SOT323	Transistor	344-27272	
Q2752	BC847BW SOT323	Transistor	344-27272	
Q2768	BC847BW SOT323	Transistor	344-27272	
Q2883	SN7002 SOT23 0A19 60V NCH	Transistor	344-29134	
Q2888	SN7002 SOT23 0A19 60V NCH	Transistor	344-29134	
Q2943	BC847BW SOT323	Transistor	344-27272	
Q2966	BC857BW SOT323	Transistor	344-28404	

Bedienteil		Control Module	Art.-Nr. 88227.050	
Pos.Nr. Item N°.	Bestell-Bezeichnung	Description	Bestell-Nr. List Part N°.	Var. Var.
	SPULEN/LAUTSPRECHER	COILS,SPEAKERS		
L8101	Relay 5V0 62R 16A 1-pol. 29x16x13	Relay	387-29279	050
T8101	Trafo Standby Q2500 EF16-4,7	Power Transformer	490-29284	050
	ALLGEM. MECHAN. TEILE	COMMON MECHANICAL PARTS		
H8206	Halter/Diode	Holder	602-27977	050
H8207	Halter/Diode	Holder	602-27977	050
	INTEGR. SCHALTUNGEN	INTEGRATED CIRCUITS		
10	IR-Empfänger TSOP-1136SF1	Coupler	353-28926	050
I8123	TL 431ACLP	Integrated Circuit	349-19817.020	050
I8131	VIPER12# SO8	Integrated Circuit	350-29281	050
I8216	IR-Empfänger TSOP-1136SF1	Coupler	353-28926.Y20	050
	DIODEN	DIODES		
10	LED 3mm grün klar	Coupler	353-28978	050
10	LED 3mm rot klar eingefärbt	Coupler	353-28981	050
D8133	Gleichrichter DF 08 S	Rectifier	354-25837	050
D8206	LED 3mm grün klar	Coupler	353-28978Y20	050
D8207	LED 3mm rot klar eingefärbt	Coupler	353-28981.Y20	050
I8122	Opto-Koppler DIP4 80V 50/80mA	Coupler	353-28638	050
	SCHALTER	SWITCHES		
S8201	Taster 5x3mm liegend	Switch	467-28928	050
S8202	Taster 5x3mm liegend	Switch	467-28928	050
S8203	Taster 5x3mm liegend	Switch	467-28928	050
S8101	Netzschalter VTROS 8022 LORL	Switch	471-28927	050
	SICHERUNGEN	FUSES		
F8133	630mA T 250V 8x8	Fuse	380-13837.020	050
	KONDENSATOREN	CAPACITORS		
C8133	4U7 M 400V	Electrolytic Capacitor	360-29280.020	050

Bedienteil		Control Module	Art.-Nr. 88227.050	
Pos.Nr. Item N°.	Bestell-Bezeichnung	Description	Bestell-Nr. List Part N°.	Var. Var.
	SMD TEILE	SMD PARTS		
D8106	0,2A 75V SOD80 LL4148	Diode	351-15015	050
D8111	0,2A 75V SOD80 LL4148	Diode	351-15015	050
D8112	0,2A 75V SOD80 LL4148	Diode	351-15015	050
D8114	0,2A 75V SOD80 LL4148	Diode	351-15015	050
D8121	1,0A 200V DO214AC FAST-GP	Diode	351-25539	050
D8131	0,2A 75V SOD80 LL4148	Diode	351-15015	050
D8138	0,2A 75V SOD80 LL4148	Diode	351-15015	050
D8201	DIOZD 12V0 J 0W5 SOD-80 ZMM12	Diode	351-17532	050
D8202	DIOZD 12V0 J 0W5 SOD-80 ZMM12	Diode	351-17532	050
D8204	DIOZD 12V0 J 0W5 SOD-80 ZMM12	Diode	351-17532	050
D8281	0,2A 75V SOD80 LL4148	Diode	351-15015	050
D8282	0,2A 75V SOD80 LL4148	Diode	351-15015	050
D8331	DIOZD 12V0 J 0W5 SOD-80 ZMM12	Diode	351-17532	050
D8336	DIOZD 12V0 J 0W5 SOD-80 ZMM12	Diode	351-17532	050
D8391	0,2A 75V SOD80 LL4148	Diode	351-15015	050
D8392	0,2A 75V SOD80 LL4148	Diode	351-15015	050
D8491	0,2A 75V SOD80 LL4148	Diode	351-15015	050
D8492	0,2A 75V SOD80 LL4148	Diode	351-15015	050
Q8111	BC847BW SOT323	Transistor	344-27272	050
Q8114	BC847BW SOT323	Transistor	344-27272	050
Q8202	BC847BW SOT323	Transistor	344-27272	050

DVB1-Modul		DVB1 Module	Art.-Nr. 88223.050	
Pos.Nr. Item N°.	Bestell-Bezeichnung	Description	Bestell-Nr. List Part N°.	Var. Var.
	ALLGEM.MECHAN.TEILE	COMMON MECHANICAL PARTS		
14	Wärmeleitfolie 10x10mm	Plasticband	190-29724.001	050
15	Wärmeleitfolie 25X25MM	Plasticband	190-29724.002	050
	INTEGR.SCHALTUNGEN	INTEGRATED CIRCUITS		
I7051	ICMOS STI5500BVA/BVB PQSP208	Integrated Circuit	350-27822	050
I7081	IC 3.3V 0,8A SO08 Volt. Regulator	Integrated Circuit	350-27212	050
I7091	IC 3.3V 0,8A SO08 Volt. Regulator	Integrated Circuit	350-27212	050
I7251	ICMOS 74 HCT125 SMD	Integrated Circuit	350-15523	050
I7301	ICMOS KM416V# TSOP50 60ns DRAM	Integrated Circuit	350-28457	050
I7311	ICMOS KM416V# TSOP50 60ns DRAM	Integrated Circuit	350-28457	050
I7321 27821	ICMOS AT 29LV010A-15TC/20TC/25TC TSOP-32 050	Integrated Circuit	350-	
I7331	ICMOS TE28F008B3T90 TSOP40	Integrated Circuit	350-28456	050
I7341	ICMOS TE28F008B3T90 TSOP40	Integrated Circuit	350-28456	050
I7371	ICMOS KM416S# TSOP50 80ns SDRAM	Integrated Circuit	350-28459	050
I7381	ICMOS KM416S# TSOP50 80ns SDRAM	Integrated Circuit	350-28459	050
I7431	ICMOS MK2727STR SO-8	Integrated Circuit	350-28090	050
I7551	IC UC3843# SO8 V-CONT	Integrated Circuit	350-29258	050
I7577	ICMOS HEF4053D SO16	Integrated Circuit	350-24881	050
I7701	IC 3.3V 0,8A SO08 Volt. Regulator	Integrated Circuit	350-27212	050
I7721	IC STV0299B TQFP64	Integrated Circuit	350-29049	050
I7861	ICMOS CS 4334 SO8	Integrated Circuit	350-27826	050
I7901	IC LM2574M-ADJ 0,5A M14B	Integrated Circuit	350-28497	050
I7931	IC-VR 12V00 G 0A25 CDT120 4931	Integrated Circuit	350-29256	050
I7981	I.C. TL 7702 ACD SO-8 LV 030	Integrated Circuit	350-27827	050
	QUARZE/FILTER	QUARTZES		
X7436	13,500000 MHz HC49U	Crystal Oscillator	385-18287	050
X7758	4,000000 MHz HC49U	Crystal Oscillator	385-17297	050

DVB1-Modul		DVB1 Module	Art.-Nr. 88223.050	
Pos.Nr. Item N°.	Bestell-Bezeichnung	Description	Bestell-Nr. List Part N°.	Var. Var.
	SMD TEILE	SMD PARTS		
D7206	0,2A 75V SOD80 LL4148	Diode	351-15015	050
D7212	0,2A 75V SOD80 LL4148	Diode	351-15015	050
D7232	0,2A 75V SOD80 LL4148	Diode	351-15015	050
D7239	0,2A 75V SOD80 LL4148	Diode	351-15015	050
D7242	0,2A 75V SOD80 LL4148	Diode	351-15015	050
D7249	0,2A 75V SOD80 LL4148	Diode	351-15015	050
D7346	0,2A 75V SOD80 LL4148	Diode	351-15015	050
D7465	LL 103 C	Diode	351-16947	050
D7466	LL 103 C	Diode	351-16947	050
D7554	3,0A 40V SOD6 Schottky	Diode	351-28529	050
D7761	1,0A 600V	Diode	351-20547	050
D7902	3,0A 40V SOD6 Schottky	Diode	351-28529	050
Q7156	BC847BW SOT323	Transistor	344-27272	050
Q7201	BC857BW SOT323	Transistor	344-28404	050
Q7211	BC847BW SOT323	Transistor	344-27272	050
Q7230	BC857BW SOT323	Transistor	344-28404	050
Q7231	BC847BW SOT323	Transistor	344-27272	050
Q7235	BC857BW SOT323	Transistor	344-28404	050
Q7240	BC857BW SOT323	Transistor	344-28404	050
Q7241	BSV52 SOT23	Transistor	344-16207	050
Q7245	BC857BW SOT323	Transistor	344-28404	050
Q7257	BC847BW SOT323	Transistor	344-27272	050
Q7341	BC857BW SOT323	Transistor	344-28404	050
Q7551	17NE03# TO252 17A0 30V NCH	Transistor	344-29257	050
Q7577	SN7002 SOT23 0A19 60V NCH	Transistor	344-29134	050
Q7580	BC847BW SOT323	Transistor	344-27272	050
Q7581	BC857BW SOT323	Transistor	344-28404	050
Q7586	BC847BW SOT323	Transistor	344-27272	050
Q7592	BC847BW SOT323	Transistor	344-27272	050
Q7812	BC857BW SOT323	Transistor	344-28404	050
Q7822	BC857BW SOT323	Transistor	344-28404	050
Q7832	BC857BW SOT323	Transistor	344-28404	050
Q7842	BC857BW SOT323	Transistor	344-28404	050
Q7852	BC857BW SOT323	Transistor	344-28404	050

Sat 6

Art.-Nr. 87699.050-052

Pos.Nr. Item N°.	Bestell-Bezeichnung	Description	Bestell-Nr. List Part N°.	Var. Var.
	BAUGRUPPEN	UNITS		
U100	SAT-Tuner DVB/FM BS2W7HG1002	Scaffolding Access.	291-28502	050
U100	SAT-Tuner DVB/FM BS2W7HG1002	Scaffolding Access.	291-28502	052
U240	SAT-Tuner SF1218/SH	Tuner	260-28462	051
U700	SAT-Tuner SF1218/SH	Tuner	260-28462	050
	INTEGR. SCHALTUNGEN	INTEGRATED CIRCUITS		
I150	IC MAX4546CSE SO16 RF/Video Switch	Integrated Circuit	350-28499	052
I300	IC LM2574M-ADJ 0,5A M14B	Integrated Circuit	350-28497	
I320	IC LM 2903D SO08	Integrated Circuit	350-21674	
I360	ICMOS SAA1300 SOT142-1	Integrated Circuit	349-28501	
I400	IC TSA5523M SOT266	Integrated Circuit	350-27275	050
I400	IC TSA5523M SOT266	Integrated Circuit	350-27275	052
I450	IC LM 358 SMD	Integrated Circuit	350-21521	050
I450	IC LM 358 SMD	Integrated Circuit	350-21521	052
I700	IC STV0056A DIP56Shrink	Integrated Circuit	349-28504	
I800	IC LM2574M-ADJ 0,5A M14B	Integrated Circuit	350-28497	050
I820	IC LM 2903D SO08	Integrated Circuit	350-21674	050
I860	ICMOS SAA1300 SOT142-1	Integrated Circuit	349-28501	050
I900	IC TDA6151 SO20	Integrated Circuit	350-23124	050
	QUARZE/FILTER	QUARTZES		
X789	Quarz 4,000000 MHz HC49U	Crystal Oscillator	385-20171	
	WIDERSTÄNDE	RESISTORS		
R301	1R J 0207	Resistor	367-24709.020	
R801	1R J 0207	Resistor	367-24709.020	050
	SMD TEILE	SMD PARTS		
D301	3,0A 40V SOD6 Schottky	Diode	351-28529	051
D301	3,0A 40V SOD6 Schottky	Diode	351-28529	052
D303	1,0A 600V	Diode	351-20547	051
D303	1,0A 600V	Diode	351-20547	052
D338	ZD 5V6 SOD80 ZMM B ITT	Diode	351-22580	051
D338	ZD 5V6 SOD80 ZMM B ITT	Diode	351-22580	052
D376	LL4148 SOD80	Diode	351-15015	
D381	LL4148 SOD80	Diode	351-15015	
D613	LL4148 SOD80	Diode	351-15015	
D613	BAS316 SOD323	Diode	351-27952	051
D614	BAS316 SOD323	Diode	351-27952	051
D616	BAS316 SOD323	Diode	351-27952	051
D624	BAS316 SOD323	Diode	351-27952	051
D626	LL4148 SOD80	Diode	351-15015	

Sat 6

Art.-Nr. 87699.050-052

Pos.Nr. Item N°.	Bestell-Bezeichnung	Description	Bestell-Nr. List Part N°.	Var. Var.
	SMD TEILE	SMD PARTS		
D626	BAS316 SOD323	Diode	351-27952	051
D627	BAS316 SOD323	Diode	351-27952	051
D876	LL4148 SOD80	Diode	351-15015	050
D881	LL4148 SOD80	Diode	351-15015	050
Q103	SI2302DS MOSF. N- 1,25W SOT23	Transistor	344-28503	050
Q103	SI2302DS MOSF. N-Kanal 1,25W SOT23	Transistor	344-28503	052
Q104	SI2302DS MOSF. N-Kanal 1,25W SOT23	Transistor	344-28503	050
Q104	SI2302DS MOSF. N-Kanal 1,25W SOT23	Transistor	344-28503	052
Q107	BC847BW SOT323	Transistor	344-27272	050
Q107	BC847BW SOT323	Transistor	344-27272	052
Q108	BCR148W SOT323	Transistor	344-27270	050
Q108	BCR148W SOT323	Transistor	344-27270	052
Q109	BCR148W SOT323	Transistor	344-27270	050
Q109	BCR148W SOT323	Transistor	344-27270	052
Q121	BC847BW SOT323	Transistor	344-27272	050
Q121	BC847BW SOT323	Transistor	344-27272	052
Q316	BCR148W SOT323	Transistor	344-27270	
Q318	BC847BW SOT323	Transistor	344-27272	
Q334	BC847BW SOT323	Transistor	344-27272	
Q340	BC847BW SOT323	Transistor	344-27272	
Q352	BC847BW SOT323	Transistor	344-27272	
Q354	BC847BW SOT323	Transistor	344-27272	
Q364	BCR148W SOT323	Transistor	344-27270	
Q366	BCR148W SOT323	Transistor	344-27270	
Q367	BCR148W SOT323	Transistor	344-27270	
Q368	BCR148W SOT323	Transistor	344-27270	
Q374	BC847BW SOT323	Transistor	344-27272	
Q377	BC847BW SOT323	Transistor	344-27272	
Q392	BCR148W SOT323	Transistor	344-27270	
Q393	BC847BW SOT323	Transistor	344-27272	
Q553	BC847BW SOT323	Transistor	344-27272	
Q658	BC857W SOT323	Transistor	344-27468	050
Q658	BC857BW SOT323	Transistor	344-28404	051
Q658	BC857W SOT323	Transistor	344-27468	052
Q679	BC857W SOT323	Transistor	344-27468	050
Q679	BC857BW SOT323	Transistor	344-28404	051
Q679	BC857W SOT323	Transistor	344-27468	052
Q712	BF799LK	Transistor	344-17798	

Sat 6**Art.-Nr. 87699.050-052**

Pos.Nr. Item N°.	Bestell-Bezeichnung	Description	Bestell-Nr. List Part N°.	Var. Var.
	SMD TEILE	SMD PARTS		
Q723	BC857W SOT323	Transistor	344-27468	050
Q723	BC857BW SOT323	Transistor	344-28404	051
Q723	BC857W SOT323	Transistor	344-27468	052
Q752	BC847B SOT23	Transistor	344-14974	
Q757	BC847B SOT23	Transistor	344-14974	050
Q816	BCR148W SOT323	Transistor	344-27270	050
Q818	BC847BW SOT323	Transistor	344-27272	050
Q834	BC847BW SOT323	Transistor	344-27272	050
Q840	BC847BW SOT323	Transistor	344-27272	050
Q841	BCR148W SOT323	Transistor	344-27270	050
Q842	BC847BW SOT323	Transistor	344-27272	050
Q852	BC847BW SOT323	Transistor	344-27272	050
Q854	BC847BW SOT323	Transistor	344-27272	050
Q864	BCR148W SOT323	Transistor	344-27270	050
Q866	BCR148W SOT323	Transistor	344-27270	050
Q867	BCR148W SOT323	Transistor	344-27270	050

Sat 6**Art.-Nr. 87699.050-052**

Pos.Nr. Item N°.	Bestell-Bezeichnung	Description	Bestell-Nr. List Part N°.	Var. Var.
	SMD TEILE	SMD PARTS		
Q868	BCR148W SOT323	Transistor	344-27270	050
Q874	BC847BW SOT323	Transistor	344-27272	050
Q877	BC847BW SOT323	Transistor	344-27272	050
Q913	BC847BW SOT323	Transistor	344-27272	050
Q927	BC847BW SOT323	Transistor	344-27272	050
Q933	BC857W SOT323	Transistor	344-27468	050
Q934	BC847BW SOT323	Transistor	344-27272	050
Q941	BC857W SOT323	Transistor	344-27468	050
Q943	BC847BW SOT323	Transistor	344-27272	050
Q948	BC857B SOT23	Transistor	344-14979	050
Q952	BC857W SOT323	Transistor	344-27468	050
Q957	BC847BW SOT323	Transistor	344-27272	050
Q969	BCR198W SOT323	Transistor	344-27269	050
Q971	BC857W SOT323	Transistor	344-27468	050
Q976	BC847B SOT23	Transistor	344-14974	050

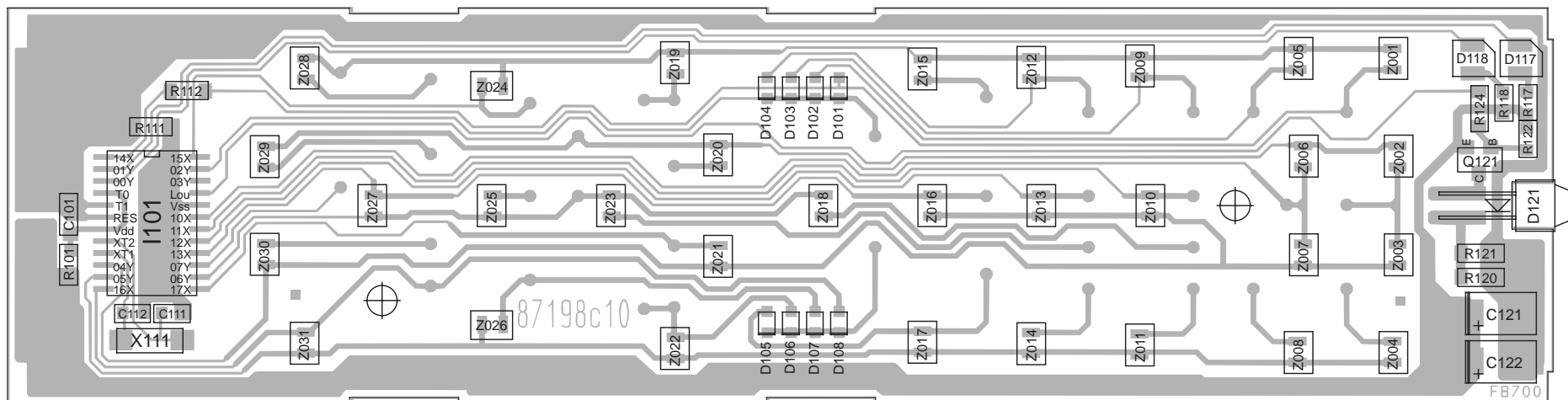

Ltpl. IR-Fernbedienung 396-87198C

Lötseite

Infrared remote control PCB 396-87198C

Solder side

IR-Fernbedienung IR remote control Art.-Nr. 87000.050

Pos.Nr. Item N ^o .	Bestell-Bezeichnung	Description	Bestell-Nr. List Part N ^o .	Var. Var.
GEBER-ERSATZTEILE		SPARE PARTS FOR TRANSMITTER		
20	Batteriefeder	Spring	739-87217001	050
20	Batteriefeder	Spring	739-87217001	050
20	Gehäuse-Oberteil Control 100	Cover	756-87265002	050
25	Lichtleiter	Window	666-87274001	050
30	Kontaktmatte Control 100	Spring Contact	309-87266001	050
70	Gehäuse-Unterteil Control 100/200 schw	Cover	756-87264002	050
80	Batteriefeder 2-fach	Spring	739-85279001	050
90	Batteriedeckel Control 100/200/201/USA	Cover	756-87215002	050
D101	Diode BAS216 SOD110	Diode	351-27279	050
D105	Diode BAS216 SOD110	Diode	351-27279	050
D107	Diode BAS216 SOD110	Diode	351-27279	050
D117	LED LG T679 SMD	Coupler	353-27021	050
D118	LED LG T679 SMD	Coupler	353-27021	050
D121	Diode LED F.D.SFH 4515	Coupler	353-27024	050
D121	Diode LED F.D.SFH 4515	Coupler	353-27024	050
I101	ICMOS PCA84C122AT-231	Integrated Circuit	350-27787	050
Q121	Transistor BCX17 SOT23	Transistor	344-25509	050
X111	Piezo Filter 4,30 MHz MELF 2,8x7	Ceramic Filter	386-27022	050

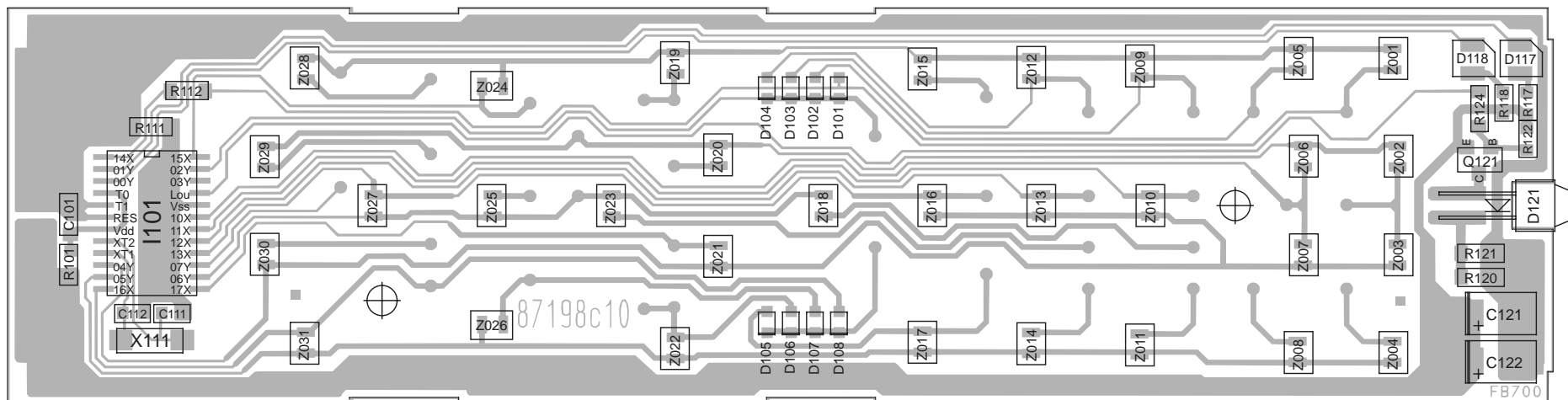

Ltpl. IR-Fernbedienung 396-87198C

Lötseite

Infrared remote control PCB 396-87198C

Solder side

IR-Fernbedienung IR remote control Art.-Nr. 87000.052

Pos.Nr. Item N°.	Bestell-Bezeichnung	Description	Bestell-Nr. List Part N°.	Var. Var.
---------------------	---------------------	-------------	------------------------------	--------------

GEBER-ERSATZTEILE		SPARE PARTS FOR TRANSMITTER		
20	Batteriefeder	Spring	739-87217001	052
20	Batteriefeder	Spring	739-87217001	052
20	Gehäuse-Oberteil neutral	Cover	756-87265008	052
25	Lichtleiter	Window	666-87274001	052
30	Kontaktmatte Control 100	Spring Contact	309-87266001	052
70	Gehäuse-Unterteil Control 100/200 sw	Cover	756-87264002	052
80	Batteriefeder 2-fach	Spring	739-85279001	052
90	Batteriedeckel Control 100/200/201/USA	COVER	756-87215002	052
D101	Diode BAS216 SOD110	Diode	351-27279	052
D105	Diode BAS216 SOD110	Diode	351-27279	052
D107	Diode BAS216 SOD110	Diode	351-27279	052
D117	LED LG T679 SMD	Coupler	353-27021	052
D118	LED LG T679 SMD	Coupler	353-27021	052
D121	Diode LED F.D.SFH 4515	Coupler	353-27024	052
I101	ICMOS PCA84C122AT-231	Integrated Circuit	350-27787	052
Q121	Transistor BCX17 SOT23	Transistor	344-25509	052
X111	Piezo Filter 4,30 MHz MELF 2,8x7	Ceramic Filter	386-27022	052

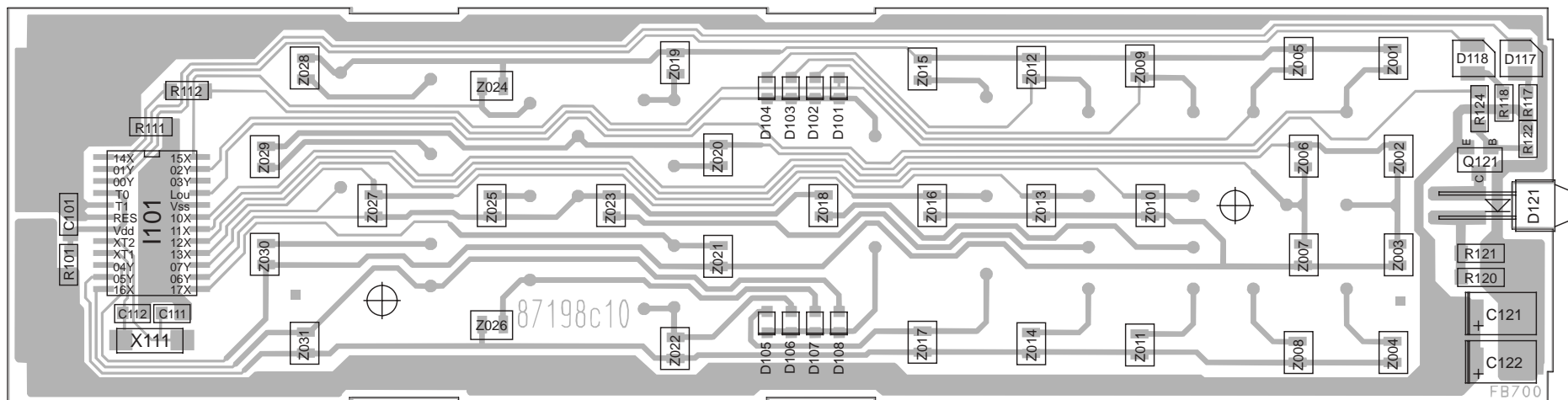

Ltpl. IR-Fernbedienung 396-87000.060 - 87198C

Lötseite

Infrared remote control PCB 396-87000.060 - 87198C

Solder side

IR-Fernbedienung IR remote control Art.-Nr. 87000.060

Pos.Nr. Item N°.	Bestell-Bezeichnung	Description	Bestell-Nr. List Part N°.	Var. Var.
---------------------	---------------------	-------------	------------------------------	--------------

Pos.Nr. Item N°.	Bestell-Bezeichnung	Description	Bestell-Nr. List Part N°.	Var. Var.
GEBER-ERSATZTEILE		SPARE PARTS FOR TRANSMITTER		
20	Batteriefeder	Spring	739-87217001	060
20	Gehäuse-Oberteil Arktis	Cover	756-87265001	060
25	Lichtleiter	Window	666-87274001	060
30	Kontaktmatte Control 150	Spring Contact	309-87267001	060
70	Gehäuse-Unterteil Arktis	Cover	756-87264001	060
80	Batteriefeder 2-fach	Sring	739-85279001	060
90	Batteriedeckl Arktis	Cover	756-87215001	060
D105	Diode BAS216 SOD110	Diode	351-27279	060
D117	LED LG T679 SMD	Coupler	353-27021	060
D118	LED LG T679 SMD	Coupler	353-27021	060
D121	Diode LED F.D.SFH 4515	Coupler	353-27024	060
I101	ICMOS PCA84C122AT-231	Integrated Circiut	350-27787	060
Q121	Transistor BCX17 SOT23	Transistor	344-25509	060
X111	Piezo Filter 4,30 MHZ MELF 2,8x7	Ceramic Filter	386-27022	060

Tabelle Basic-Board

Art.-Nr. 88175.065-099

Varianten:

Pos.	Bestell-Nr.	Bestell-Bezeichnung	Varianten:																	
			65	66	80	81	82	83	84	86	87	90	91	93	94	95	96	97	98	99
B204	85840001	524 KURZSCHLUSSBRUECKE				1	1	1							1			1	1	1
B206	85840001	524 KURZSCHLUSSBRUECKE				1	1	1							1			1	1	1
B210	85840001	524 KURZSCHLUSSBRUECKE	1	1	1					1	1	1	1	1		1	1			
B214	85840001	524 KURZSCHLUSSBRUECKE	1	1	1					1	1	1	1	1		1	1			
B222	85840001	524 KURZSCHLUSSBRUECKE				1	1	1							1			1	1	1
B473	85840001	524 KURZSCHLUSSBRUECKE				1	1	1							1			1	1	1
B474	85840001	524 KURZSCHLUSSBRUECKE				1	1	1							1			1	1	1
B541	85840001	524 KURZSCHLUSSBRUECKE	1	1		1	1	1	1						1			1	1	1
B543	85840001	524 KURZSCHLUSSBRUECKE	1	1		1	1	1	1				1	1	1	1	1	1	1	1
B544	85840001	524 KURZSCHLUSSBRUECKE	1	1		1	1	1	1				1	1	1	1	1	1	1	1
B545	85840001	524 KURZSCHLUSSBRUECKE				1														
B567	85840001	524 KURZSCHLUSSBRUECKE	1		1		1	1		1	1	1						1	1	
B576	85840001	524 KURZSCHLUSSBRUECKE	1		1		1	1		1	1	1						1	1	
B577	85840001	524 KURZSCHLUSSBRUECKE	1		1		1	1		1	1	1						1	1	
B579	85840001	524 KURZSCHLUSSBRUECKE		1		1			1				1	1	1	1	1			1
C531	25292	KOND 2N7 J 2000V	1	1	1		1	1	1	1					1			1	1	1
	25293	KOND 3N0 J 2000V											1	1		1	1			
	26372	KOND 1N8 J 2000V				1														
	26835	KOND 2N2 J 2000V									1	1								
C539	24639	KOND 1N2 J 2000V									1	1	1							
	29485	KOND 1N0 J2000V			1					1										
C541	25295	KOND 9N4 H	1																	
	25296	KOND 8N8 H		1						1		1	1		1	1	1	1		1

Tabelle Basic-Board

Art.-Nr. 88175.065-099

Varianten:

Pos.	Bestell-Nr.	Bestell-Bezeichnung	Varianten:																	
			65	66	80	81	82	83	84	86	87	90	91	93	94	95	96	97	98	99
C541	26060	KOND 8N4 H																1	1	
	26619	KOND 9N1 H											1							
	27603	KOND 7N5 H2000V			1		1	1		1										
	28113	KOND 4N1 H2000V				1														
C542	24450	KOND 600N J 250V											1	1		1	1			
	25257	KOND 470N J 250V				1	1	1												
	25886	KOND 520N J 250V		1	1					1	1	1	1		1			1	1	1
	28116	KOND 680N J 250V	1																	
C543	25294	KOND 27N J 630V											1							
	26487	KOND 10N J 630V				1														
	26531	KOND 22N J 630V	1																	
	27012	KOND 25N J 630V		1	1		1	1	1	1	1	1		1	1	1	1	1	1	1
C544	16573	KOND 750N J 250V	1											1		1	1	1	1	1
	24450	KOND 600N J 250V				1														
	28116	KOND 680N J 250V			1		1	1		1			1							
	73806	KOND 900N J 160VV (250 V-)		1						1		1	1		1					1
C545	28868	KOND 390P J 2000V			1						1	1	1							
C553	28868	KOND 390P J 2000V			1						1	1	1							
C561	11762020	ELKO 22U S 250V	1		1		1	1		1	1	1						1	1	
C563	20257020	ELKO 220U M 50V		1		1				1			1	1	1	1	1			1
C577	12156020	KOND 1N5 J 63V		1			1	1	1		1	1		1				1	1	1
	20455020	KOND 1N K 50V	1		1						1									
	21367020	KOND 2N2 K 50V											1	1		1	1			

